

# Applications and Operation of the 8901A Modulation Analyzer



Application Note 286-1



HEWLETT  
PACKARD

**Application Note 286-1**

**Applications and Operation  
of the 8901A Modulation Analyzer**

# Contents

<b>1. Introduction</b> .....	1	Accounting for Peak Residuals .....	21
<b>2. Applications</b> .....	3	RF Level Measurement .....	22
Mobile Radio Transmitter Testing .....	3	Reverse Power Protection .....	
Common Transmitter Tests with the 8901A .....	4	Tuned RF Level Measurement .....	22
Power .....		Measuring Carrier Harmonics .....	
Frequency Error .....		IF Level Mode .....	23
Microphone Sensitivity .....		High Sensitivity FM Measurements .....	
Incidental AM .....		High Sensitivity AM Measurements .....	
Audio Distortion .....		AM Measurements Relative to .....	
Audio Flatness .....		the Unmodulated Carrier .....	
Modulation Limiting .....		Track Mode .....	24
Residual Modulation (Hum and Noise) .....		IF Filter Characteristics .....	25
Automatic Transmitter Testing .....	6	Audio Filter Characteristics .....	26
Signal Generator Calibration .....	7	Peak Hold Detector .....	27
AM Accuracy .....		Special Function Operation .....	27
FM Accuracy .....		<b>5. Calibrator Operation and Theory</b> .....	29
Residual FM .....		Introduction .....	29
Frequency Accuracy .....		AM Calibrator .....	29
RF Level Functional Check .....		Generating the AM Calibrator Signal .....	
General R&D Use .....	11	Calculating AM Calibrator Depth .....	
Oscillator Characterization .....		Comparing Measured with Calculated AM Depth .....	
Receiver Design .....		FM Calibrator .....	31
Extending the 8901A Frequency Range .....		Generating the FM Calibrator Signal .....	
<b>3. Theory of Operation</b> .....	15	and Calculating Deviation .....	
Input .....	15	Comparing Measured with Calculated .....	
Intermediate Frequency (IF) .....	15	FM Deviation .....	
AM and FM Demodulators .....	15	Verifying Accuracy .....	32
Audio Filters .....	15	Calibrator Special Functions .....	32
De-emphasis .....	15	Verifying the Accuracy of a Second 8901A .....	32
Detectors .....	15	Improving Accuracy Using .....	
Local Oscillator .....	16	the Calibration Factor .....	33
<b>4. Performance and Operation</b> .....	17	<b>6. Remote Operation</b> .....	35
Frequency Measurement .....	17	Displaying and Setting the Address .....	35
High Sensitivity (0.22mV) Count Mode .....		Program Codes .....	36
Amplitude Modulation Measurement .....	18	Code Simplifications and Conventions .....	36
Measuring AM Depths Greater than 100% .....		Programming Order Considerations .....	38
AM Flatness .....		Triggered Operation .....	38
Frequency Modulation Measurement .....	19	Output Data Message Format .....	39
Carrier Shift .....		Service Request and Status Reporting .....	39
Residual FM .....		Programming Execution Time .....	40
Frequency-Shift Keying .....		Device Subroutines .....	41
Stereo Separation .....		Example Program .....	47
		Bus Commands .....	51

# 1. Introduction

The 8901A Modulation Analyzer is a calibrated receiver that combines several RF measurement capabilities in one instrument. It measures modulation (AM, FM,  $\Phi$ M), frequency, and power automatically, with all major functions requiring only a single keystroke. Once the function is selected, the 8901A automatically tunes to the input signal, selects the appropriate range, makes the measurement, and displays the result. Accuracy for AM and FM is 1% of reading for most rates and depths, or deviations. Low internal noise and high separation between AM and FM demodulators make possible measurement of small amounts of residual or incidental modulation. Several front panel keys put the analyzer in special measurement modes. For example, the FM de-emphasis PRE-DISPLAY mode greatly simplifies measuring flatness of pre-emphasized FM transmitters; the PEAK HOLD mode captures modulation transients

for broadcast monitoring, and the percent and dB ratio modes provide flexible display formats. These features and capabilities make the 8901A ideal for demanding applications such as signal generator calibration and transmitter testing.

This application note contains information for making full use of the analyzer's capabilities. It includes step-by-step procedures for calibrating signal generators, measuring VCO linearity, and testing FM transmitters (section 2); brief theory of operation (section 3); descriptions and uses of the special functions (section 4); theory and operation of the optional calibrators (section 5); and remote HP-IB<sup>1</sup> operation with various Hewlett-Packard controllers (section 6).

<sup>1</sup> HP-IB is Hewlett-Packard's implementation of IEEE Standard 488.

## 2. Applications

The performance and features of the Modulation Analyzer make it a versatile RF measurement tool. As a bench instrument used with an audio oscillator the 8901A performs most mobile radio transmitter tests in several keystrokes. The percent and dB relative ratio modes provide flexible display formats. These features along with standard de-emphasis and audio filters simplify many measurements that are presently tedious. For example, flatness of pre-emphasized FM transmitters can be measured directly in dB by merely sweeping audio frequency into the transmitter microphone input. Besides ease of use, unprecedented accuracy and the internal calibrator option make the 8901A ideal for calibrating signal generators. High AM and FM separation and a low noise local oscillator make the 8901A useful as a general purpose lab instrument for incidental and residual modulation measurements and in characterizing crystal oscillators. Other applications include IC testing, broadcast monitoring, and testing ILS transmitters. This section describes several major applications of the 8901A Modulation Analyzer.

### Mobile Radio Transmitter Testing

In the design of the Modulation Analyzer careful attention was given to testing requirements of mobile transmitters. Three of the most important measurements commonly made are

- Power output**
- Frequency error**
- Modulation limiting**

These measurements are important because they have a direct bearing on the transmitter's operating range and because of government regulations. The 8901A measures power, frequency, and modulation with single keystrokes. Besides these basic measurement capabilities, the Modulation Analyzer contains the appropriate FM de-emphasis filters, post detection measurement bandwidth filters, and detectors required for performing almost all of the standard mobile transmitter tests as specified in EIA Standards RS-152B and RS-382A, and CEPT Recommendation TR/17 Annex I, II, and III. The 8901A meets the vast majority of transmitter testing requirements when used with an audio source to provide test tones for the transmitter microphone input. In tables 2-1 through 2-4 the 8901A test capabilities are compared with the most widely accepted industry standards.

**Table 2-1.** FM mobile transmitter tests per CEPT Recommendation TR/17 Annex I, II, and III

Test	Can 8901A Test?	Comments
Frequency Tolerance	Yes	
Carrier Power	Yes	Requires a power attenuator for levels > 1 watt.
Adjacent Channel Power	No	
Conducted Spurious Emission	No	
Maximum Permissible Frequency Deviation	Yes	
Transmitter Modulator Limiting Characteristic	Yes	
Frequency Deviation Reduction for Modulation Frequency > 3 kHz	Yes	The 8901A dB ratio mode provides direct display of measurement results according to the specification.
Modulator Sensitivity, Including the Microphone	Yes	An acoustic transducer is required.
Transmitter Audio Frequency Response	Yes	
Audio Frequency Harmonic Distortion	Yes	Requires a distortion analyzer connected to the MODULATION OUTPUT.
Residual Transmitter Modulation	Yes	

**Table 2-2.** AM transmitter tests per EIA RS-382A

Test	Can 8901A Test?	Comments
Carrier Output Power	Yes	Requires a power attenuator for levels > 1 watt.
Conducted Spurious Emissions	Limited	8901A can measure carrier harmonics to approximately -50 dBc (or minimum absolute levels of -50 dBm).
Radiated Spurious Emissions	No	
Audio Frequency Harmonic Distortion	Yes	Requires a distortion analyzer.
Audio Frequency Response	Yes	
Hum and Noise Level	Yes	
Transmitter Frequency Stability	Yes	
Transmitter Modulation Spectrum	No	Requires a spectrum analyzer.

**Table 2-3.** FM mobile transmitter tests per EIA RS-152B

Test	Can 8901A Test?	Comments
Carrier Power	Yes	Requires a power attenuator for levels > 1 watt.
Conducted Spurious Emission	No	
Radiated Spurious Emission	No	
Audio Frequency Harmonic Distortion	Yes	Requires a distortion analyzer connected to MODULATION OUTPUT of 8901A.
Audio Frequency Response	Yes	
FM Hum and Noise	Yes	
Modulation Limiting Instantaneous	Yes	
Steady State	Yes	
Carrier Frequency Stability	Yes	8901A measures frequency to 10 Hz resolution. External test chambers must provide varying temperature and humidity.
AM Hum & Noise	Yes	
Transmitter Sideband Spectrum	No	Requires a spectrum analyzer.
Carrier Attack Time	Yes	Requires a storage oscilloscope connected to 8901A IF OUTPUT.

**Table 2-4.** Single sideband (SSB) transmitter tests per EIA RS-424

Test	Can 8901A Test?	Comments
Peak Envelope Power Output (Two Tone)	Yes	Requires power attenuator for levels > 1 watt.
Conducted Spurious Emissions	Limited	8901A can measure carrier harmonics to approximately -50 dBc (or minimum absolute levels of -50 dBm).
Radiated Spurious Emissions	No	
Audio Frequency Response	Yes	
Frequency Stability	Yes	
Intermodulation Distortion	No	Requires a spectrum analyzer.

## Common Transmitter Tests with the 8901A

With the 8901A most transmitter tests require only a few keystrokes. Several features like PEAK HOLD and PRE-DISPLAY really simplify measurements that are presently difficult or tedious to perform. The percent and dB ratio modes allow the 8901A to display measurement results in the units that are most often used. For example, FM hum and noise can be displayed in dB down from a user-entered reference deviation. The following procedures show how to perform the most common transmitter tests with the 8901A. Some of the examples shown are for FM transmitters. However, the 8901A works equally well with AM or  $\Phi$ M transmitters.

### Power

The 8901A measures power in watts in RF level mode. Sometimes dBm is preferred to watts. Since 0 dBm is 1 milliwatt the keystrokes to display power in dBm are



The 8901A measures power for inputs up to 1 watt (+30 dBm), and is relay protected for overloads up to 25 watts. The error message "E06" is displayed when an overload occurs. Normal operation resumes after any key is pressed and the overload condition is no longer present.

### Frequency Error

The Analyzer measures the transmitter frequency in frequency mode. In normal operation the 8901A automatically adjusts the counter resolution as a function of input frequency to obtain a display rate of 3.6 readings/second. This constant display rate can be overridden with special functions in favor of better resolution. For maximum resolution (10 Hz) use the 7.1 special function. The keystrokes are



Special functions are described further in sections 4 and 6. The 8901A can also display frequency error. The keystrokes to measure the frequency error of a 464.55 MHz transmitter are



The display indicates the frequency error. Frequency error can also be displayed in parts per million (ppm) using percent ratio mode. After the previous keystrokes enter 0.1 times the frequency input in MHz (46.455 for this example) and press the percent ratio key.

## Microphone Sensitivity

Microphone sensitivity is the audio level at the transmitter microphone input that produces standard test modulation on the transmitter output. Standard test modulation is defined as a 1 kHz rate and 30% depth for AM transmitters or 3 kHz peak deviation for FM mobile transmitters. For an FM transmitter the keystrokes are



The audio level is adjusted until the 8901A indicates standard modulation (Figure 2-1). This audio level is used as the reference microphone input for several of the following tests.

## Incidental AM

Incidental AM is the amount of AM modulation produced when the transmitter is frequency modulated to standard test deviation. Incidental AM is measured by pressing the AM key.

## Audio Distortion

Transmitter audio distortion is measured with the equipment setup of Figure 2-1 with a distortion analyzer connected to the 8901A MODULATION OUTPUT. The audio source level should be adjusted to produce standard test modulation. The recovered modulation is available at the MODULATION OUTPUT. Most FM transmitters employ pre-emphasis which boosts the level of high frequency audio signals at the microphone input. FM receivers low-pass filter the recovered audio with de-emphasis to reproduce the original microphone input signal. The 8901A has four de-emphasis networks including 25  $\mu$ s for Dolby FM broadcast, 50  $\mu$ s for European FM broadcast, 75  $\mu$ s for U.S. FM broadcast, and 750  $\mu$ s for mobile radio transmitters. When selected these de-emphasis networks low-pass filter the MODULATION OUTPUT signal. The appropriate network should always be used when measuring FM transmitter distortion.

## Audio Flatness

Transmitter audio flatness is the change in modulation as the frequency of the microphone audio input signal is varied. For FM transmitters the change in modulation is measured with respect to the appropriate pre-emphasis characteristic. FM mobile transmitter flatness is normally measured (per EIA Standard RS-152B) by monitoring the

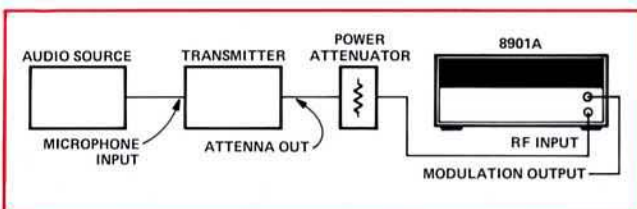

Figure 2-1. Transmitter test setup.

audio input level required to produce 30% rated deviation as the audio source frequency is varied from 300 Hz to 3 kHz. This procedure is time consuming since it requires level adjustment at each frequency. The 8901A features a special de-emphasis mode called PRE-DISPLAY which greatly simplifies measuring FM flatness. PRE-DISPLAY mode positions the de-emphasis network before the modulation measurement detectors and the 8901A performs as a standard receiver for measuring flatness directly (Figure 2-2). Furthermore, in dB ratio mode the analyzer displays the response in dB relative to a desired reference rate (usually 1 kHz). The 8901A measures FM mobile transmitter audio flatness with the following procedure:

1. Press



2. Set the audio source to 1 kHz and adjust the level to produce 20% rated deviation.

**Note:** 20% is used rather than 30% to avoid possible audio limiting problems near 3 kHz rates.

3. Press



4. Vary the audio frequency between 300 Hz and 3 kHz. The 8901A indicates the transmitter audio frequency response in dB.

## Modulation Limiting

Modulation limiting is a measure of the ability of the audio limiters to prevent the transmitter from overmodulating and disrupting communication in nearby channels. Both instantaneous and steady state limiting are measurements of interest. The 8901A features a special detector mode called PEAK HOLD that greatly simplifies measuring instantaneous limiting. In PEAK HOLD mode the peak detector decay time constant is greatly increased and the display is updated only by larger measurement results. PEAK HOLD is usable with either the PEAK + or PEAK - detectors and in AM, FM,

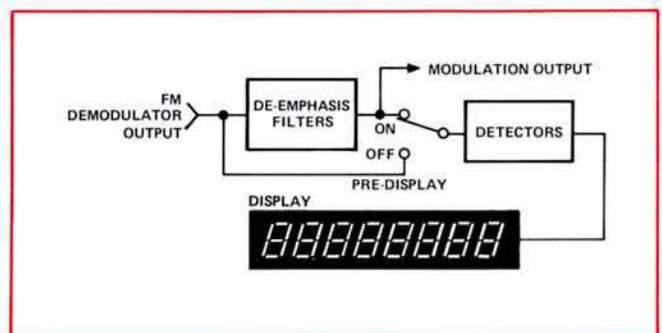

Figure 2-2. 8901A PRE-DISPLAY de-emphasis mode.

or  $\Phi$ M mode. The 8901A measures instantaneous limiting of FM mobile transmitters with the following procedure:

1. Press



and adjust for standard test deviation.

2. Press



and suddenly increase and decrease the audio level 20 dB. Repeat the transient several times to ensure that the 8901A captures the largest transient. The display indicates the instantaneous limiting in kHz.

3. Steady state limiting can also be measured. With the audio level increased 20 dB press either PEAK + or PEAK -. This takes the 8901A out of PEAK HOLD mode.

Before the 8901A, the most common method of measuring instantaneous modulation limiting was using a calibrated storage oscilloscope technique with a modulation meter demodulated output. The scope method takes longer to set up, provides limited accuracy, and cannot be automated.

### Residual Modulation (Hum and Noise)

Residual modulation is a measure of the hum and noise of the unmodulated transmitter. The 8901A has an average responding detector that is helpful in making noise measurements. The AVG detector is average responding but rms sinewave calibrated. It is used when measuring residual modulation because average or rms reading of noise is more appropriate than peak measurements. Residual FM is often measured in a 300 Hz to 3 kHz bandwidth. To make this measurement the audio source is removed from the microphone input and the following keystrokes made:

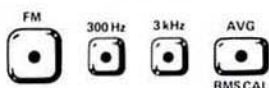

The display indicates the residual FM. For FM mobile transmitters hum and noise is defined as the ratio of the output of a standard receiver with de-emphasis when the transmitter is modulated and unmodulated. Hum and noise is usually expressed in dB referenced to 3 kHz peak deviation. This can be displayed directly with the 8901A using the dB ratio mode. The 750  $\mu$ s filter attenuates a 1 kHz signal by 13.66 dB (a factor of 0.2076). Also, since the average detector is used the rms value of the reference deviation is used. For standard

modulation the ratio reference is 0.440 ( $3.0 \times 1/\sqrt{2} \times 0.2076 = 0.440$ ) and the keystrokes are

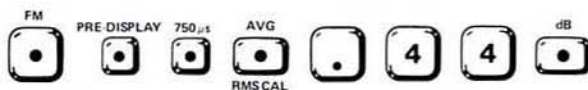

The display now indicates FM hum and noise in dB relative to 3 kHz peak deviation. The 50 Hz high-pass filter is also recommended for this measurement. The 8901A residual FM is low enough (<8 Hz @ 1300 MHz in a 50 Hz to 3 kHz bandwidth decreasing linearly with RF frequency) that it can measure directly the hum and noise of most transmitters. Section 4 contains typical curves of the 8901A residual FM.

## Automatic Transmitter Testing

The Modulation Analyzer is fully programmable and HP-IB operation is standard. All of the common tests just described (except distortion) can be automated with the Modulation Analyzer, a programmable audio source, desktop computer, and plotter (Figure 2-3). An example program using this equipment performs a comprehensive characterization of the transmitter automatically. Figure 2-4 shows a sample output. The program takes approximately 4 minutes to run—2½ minutes to label the titles and graphs, and 1½ minutes to perform the measurements. A listing and description of the program is included in section 6.

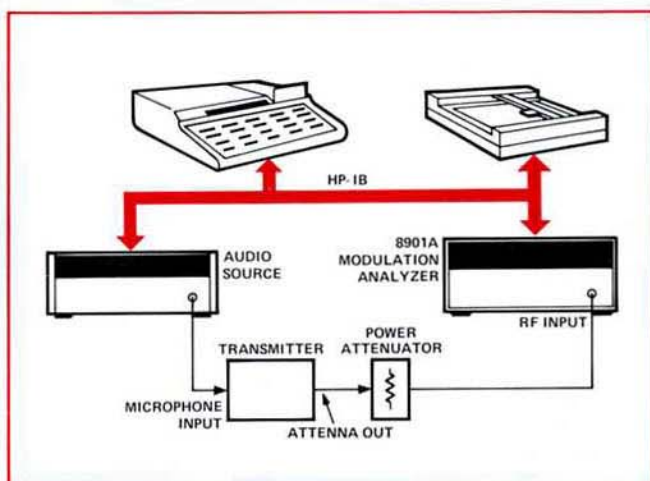

Figure 2-3. Automated FM transmitter testing



## Signal Generator Calibration

Signal Generator calibration is another major application of the 8901A Modulation Analyzer. The 8901A is ideally suited for testing signal generators because it is the electrical dual of a signal generator; signal generators are calibrated transmitters and the Modulation Analyzer is a calibrated receiver. The outstanding accuracy and low noise of the 8901A enable it to test the modulation performance characteristics of the finest signal generators. This accuracy is easily verified with the optional calibrators which are essentially a secondary modulation standard. Because the 8901A makes modulation measurements directly it substantially reduces the amount of test equipment required to perform modulation calibration (Table 2-5). Calibration time is also significantly reduced because many adjustments on other instruments are eliminated. Table 2-6 compares the time required to calibrate the modulation of the HP 8640B Signal Generator with and without the 8901A. The test times listed include time to read, perform, and record the results for each procedure. Although the tests were performed on an 8640B Signal Generator, they are typical for many other signal generators. Using the 8901A the measurements are made six times faster than present techniques, saving over four hours. Also, to keep test times within reason, measurements made in the conventional way are often limited to only a few RF frequencies. In contrast, the 8901A in auto-track mode can continuously measure modulation as the generator under test is tuned through octave bands. Hence, tests made with the 8901A are much more

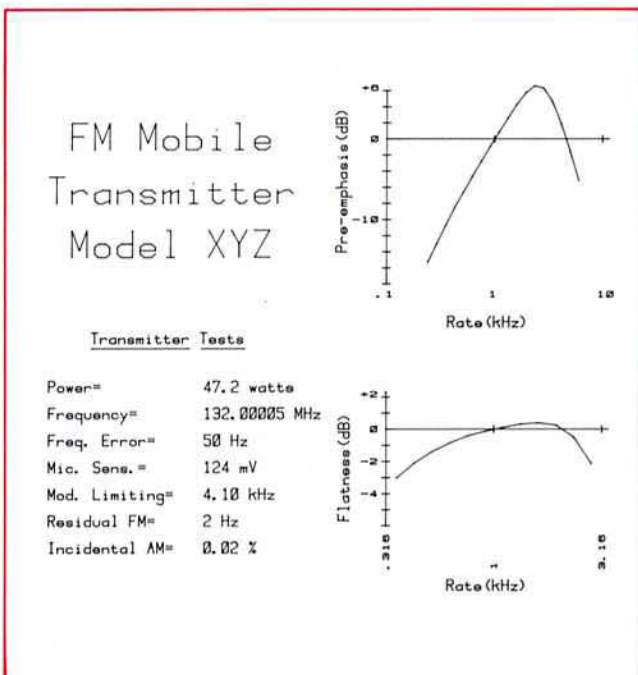

Figure 2-4. Example output of transmitter test program

thorough, yet they are performed in much less time. In summary, the 8901A is a valuable tool for anyone testing, repairing, or calibrating signal generators. The test procedures on pages 8 to 10 compare older methods and 8901A methods for several 8640B performance tests.

Table 2-5. 8640B Signal generator modulation calibration equipment comparison

With 8901A	Without 8901A
8901A Modulation Analyzer 3336A Audio Synthesizer Distortion Analyzer 11715A AM/FM Test Source 3455A Digital Voltmeter	8554B Spectrum Analyzer 8640B Reference Signal Generator 8405A Vector Voltmeter 5327C Frequency Counter 3310A Function Generator 180A Oscilloscope 331A Distortion Analyzer 3490A Digital Voltmeter 651A Test Oscillator 3400A Voltmeter 5210A Frequency Discriminator 465A Amplifier 355D Step Attenuator 8471A Crystal Detector 423A Crystal Detector Assorted filters, loads, and mixer

Table 2-6. 8640B Signal generator modulation calibration time comparison

Test	Test Time		Comments
	with 8901A	without 8901A	
<b>AM Tests</b>			
AM Accuracy	3	30	Requires distortion analyzer.
Residual AM	2	15	
AM Distortion	5	15	
AM Bandwidth	5	15	Requires audio synthesizer.
AM Sensitivity	2	15	
Incidental FM	2	90	
<b>FM Tests</b>			
FM Accuracy	3	30	Requires distortion analyzer.
Residual FM	2	15	
FM Distortion	5	15	
FM Bandwidth	10	30	Requires calibrating 8901A with the HP 11715A AM/FM Test Source and audio synthesizer if rates >200 kHz are tested.
FM Sensitivity	5	15	
Incidental AM	2	15	
<b>Total Time</b>	<b>46 min</b>	<b>5 hours</b>	

## AM Accuracy

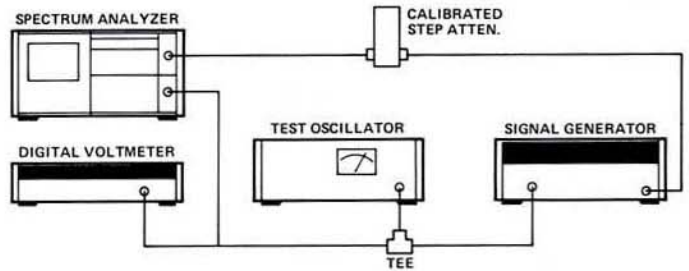
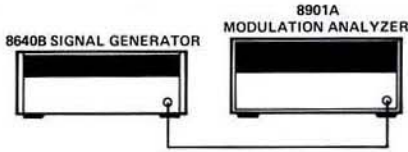

**TIME: 3 minutes with 8901A.**

**PROCEDURE:** To measure indicated AM accuracy, connect the 8901A to the 8640B Signal Generator. Using the internal 8640B audio oscillator at 400 Hz and 1 kHz rates, set various AM depths on the 8640B meter and read accuracy on the 8901A by entering the same depth on the keyboard and pressing the % ratio key. For example, with the signal generator AM depth set to 30%, key in



The 8901A now displays the accuracy in percent.

### ADDITIONAL CAPABILITY

#### Variable RF Frequency Using Track Mode

Additional time: 3 minutes.

The 8901A can also measure modulation flatness (usually measured in dB) as RF frequency is continuously varied using track mode. Set the 8640 audio oscillator to 1 kHz or greater and key in



Now vary the RF frequency. The 8901A tracks the changing RF signal and displays modulation sensitivity in dB as carrier frequency varies.

**TIME: 30 minutes without 8901A.**

**PROCEDURE:** Connect the equipment as shown. Use the spectrum analyzer as a single-frequency receiver by adjusting the analyzer to zero frequency span, linear mode, and peaking the signal using the fine frequency tune. Next, calibrate the spectrum analyzer detector so that it can be used to measure AM depth. With the step attenuator set at 0 dB adjust the reference level until the vertical output is  $-500\text{mV}$  dc. Then set 20 dB of attenuation and measure the vertical output  $V_{dc}$ . Calculate the detector offset  $V_{off}$  using

$$V_{off(mV)} = \frac{V_{dc} + 50}{0.9}$$

Reset the step attenuator to 0 dB and adjust the reference level to  $-282.8\text{ mV} + V_{off}$ . The detector is now calibrated and % AM depth is  $\frac{1}{2}$  the detector ac voltage in mV.

**Note:** The spectrum analyzer must be periodically readjusted because of drift.

## FM Accuracy

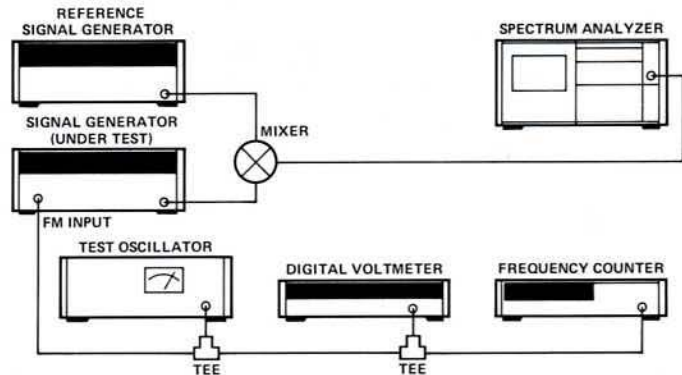
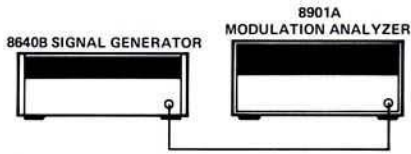

**TIME: 3 minutes with 8901A.**

**PROCEDURE:** To measure indicated FM accuracy, connect the 8901A to the 8640B. Using the internal 8640B audio oscillator at 400 Hz and 1 kHz set various FM deviations. Check the 8640B meter accuracy with the 8901A by entering the same deviation on the 8901A keyboard and pressing the % ratio key. For example, adjust the FM deviation to 5 kHz using the 8640B meter and key in



The 8901A now displays the accuracy in percent.

### ADDITIONAL CAPABILITY

#### Variable Audio Rates

Additional time: 3 minutes.

This same test can be performed at any audio rate by simply changing the frequency of the 8640B internal audio oscillator or using an external source and the EXT FM mode.

#### Variable RF Frequency

Additional time: 3 minutes.

Using track mode, FM modulation flatness is also easily measured (same keystrokes as AM Accuracy).

**TIME: 30 minutes without 8901A.**

**PROCEDURE:** The 8640B FM accuracy is measured using the carrier (Bessel) null technique. Apply an external 2.079 kHz signal to the FM input. Adjust the modulating signal amplitude for a first order carrier null. 5 kHz deviation is now set. Determine the panel meter accuracy by comparing the meter indication to the 5 kHz peak deviation. The reference generator and mixer convert the signal to the range of the spectrum analyzer. Test various carrier frequencies by re-setting both 8640Bs. This tests only one deviation (5 kHz) at one rate (2.079 kHz) and does not check at specified 400 Hz and 1 kHz rates.

**Note:** Measurement accuracy using the Bessel null technique is sensitive to incidental AM and FM distortion since either of these causes the null to shift and degrades accuracy.

## Residual FM

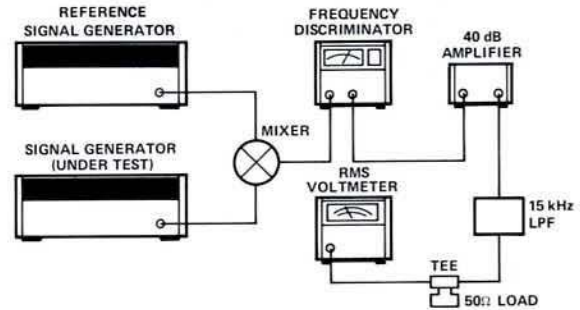
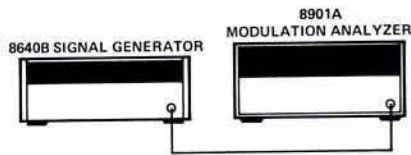

**TIME: 2 minutes with 8901A.**

### 20 Hz to 15 kHz Bandwidth

**PROCEDURE:** Connect the 8901A to the 8640B and set the 8640B AM off and FM to AC with the vernier fully clockwise. Measure residual FM by pressing

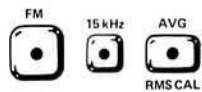

The display now indicates the residual FM.

**TIME: 15 minutes without 8901A.**

### 20 Hz to 15 kHz Bandwidth

**PROCEDURE:** Connect the equipment as shown. Turn the 8640B AM off, FM to AC (vernier fully CW). Set the reference 8640B 100 kHz lower in frequency than the generator under test. Calibrate the frequency discriminator for 1 volt output for a full scale meter deflection. Measure residual FM using the RMS voltmeter (0.5mVrms/1 Hz residual FM).

**Note:** This procedure does not measure the 300 Hz to 3 kHz specification.

### ADDITIONAL CAPABILITY

#### 300 Hz to 3 kHz Bandwidth

Additional time: 1 minute.

Residual FM for the 8640B is also specified for a measurement bandwidth of 300 Hz to 3 kHz. This measurement is accomplished with the 8901A by keying in



In addition to calibration of modulation the 8901A is also quite useful in checking proper operation of other generator parameters. Here are some examples.

### Frequency Accuracy

The 8901A measures and displays frequency or frequency error. Ratio mode along with FREQ ERROR mode allows frequency error to be displayed in parts per million (ppm). For example, if the signal generator is set to 400.0 MHz, press:

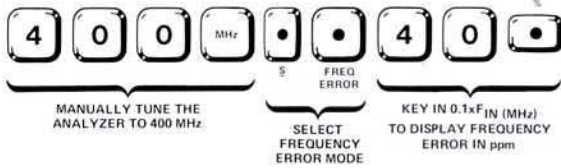

### RF Level Functional Check

The signal generator output level can be checked from +30 dBm to -20 dBm using RF LEVEL mode as follows:

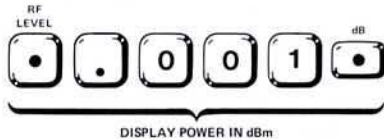

Typical accuracy is  $\pm 1$  dB (Figure 4-17, section 4). If the analyzer is manually tuned as above the RF level can be checked to -50 dBm using TUNED RF LEVEL mode with typical accuracy  $\pm 2$  dB ( $\pm 3$  dB for frequencies  $>300$  MHz).

### General R&D Use

Since the 8901A is basically a calibrated receiver, another major application is general use as a bench instrument in RF design. Here are some examples.

### Oscillator Characterization

Voltage-controlled oscillator (VCO) linearity is often measured by measuring frequency as dc input voltage is varied. The 8901A can be used in frequency mode along with a variable dc source to measure VCO linearity (Figure 2-5). Another common VCO measurement is differential nonlinearity. Differential nonlinearity is a plot of VCO modulation sensitivity ( $\Delta f/\Delta V$ ) as a function of control input voltage ( $V$ ). This plot is the derivative of the VCO's linearity transfer characteristic. Since changes in the slope of the VCO transfer characteristic are readily apparent in a modulation sensitivity curve, the plot gives useful information concerning VCO linearity. Ideally, VCO modulation sensitivity is constant, resulting in a horizontal line when plotted over the frequency range of the VCO.

The 8901A has a special tuning mode called track mode that simplifies measuring modulation sensitivity. In track mode the 8901A tracks the changing VCO

frequency while still measuring FM. The benefit is that the 8901A provides excellent modulation sensitivity over a wide range of input frequency. Previously FM discriminators were used in place of the 8901A. The VCO signal was then heterodyned to the operating frequency of the discriminator. Because of the narrow operating range of most discriminators, this technique required frequent readjustment. The 8901A measures modulation sensitivity as shown in Figure 2-5 as follows:

1. With the 8901A set to measure frequency, adjust the function generator dc off-set until the VCO is in the middle of the frequency range of interest.
2. Stimulate the VCO with a fixed-frequency sinewave ( $\approx 10$  kHz) of small amplitude and put the 8901A in FM mode using the 300 Hz high-pass, 15 kHz low-pass filter, track mode, and the average detector by pressing

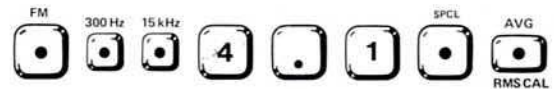

3. Establish a relative reference using either the % or dB ratio key.
4. Vary the dc offset until the VCO has covered the full frequency range of interest.

The 8901A displays the relative change in modulation sensitivity as the dc control voltage is varied. The recorder output on the rear can be used with an x-y recorder to produce a hard copy. The recorder output provides a dc voltage proportional to the peak demodulated voltage. Note that the recorder output does not give results in dB since the dB display is calculated in software.

A real time display of modulation sensitivity can also be obtained using the track mode of the 8901A. This real time linearity display capability permits oscillator designers to evaluate circuit changes quickly and accurately. The procedure is very similar to the previous one except that a second function generator is required. Adjust the dc offset of function generator #1 until the

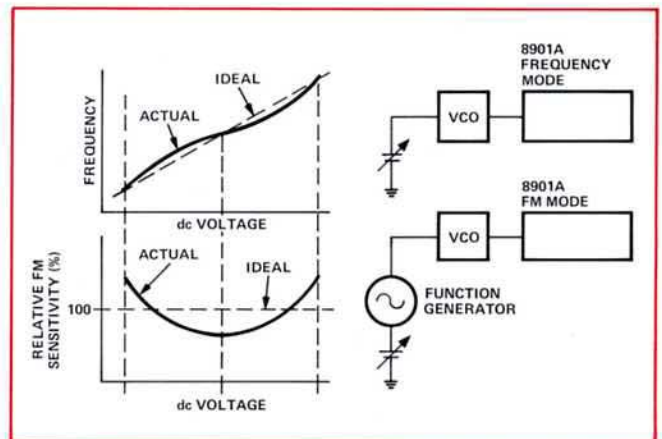

Figure 2-5. Voltage controlled oscillator characterization.

VCO frequency is in the middle of the frequency range of interest (Figure 2-6). Then set function generator #1 to a 1 Hz sinewave and adjust the amplitude for the desired VCO input voltage swing. Use this signal to calibrate the X input of the oscilloscope. Function generator #2 should be set to a 10 kHz sinewave. Adjust the amplitude to produce a reference FM deviation. Then, with the 8901A set up as before, gradually increase the frequency of generator #1 to about 50 Hz. For best results an oscilloscope with variable persistence is recommended. The 8901A can track continuously over octave bands. The band limits and other information regarding track mode are discussed further in section 4. The oscilloscope display in Figure 2-7 shows the FM modulation sensitivity of a VCO being swept from 265 to 285 MHz at a 50 Hz rate. The horizontal scale is 2 MHz/division and the vertical scale is 20 kHz/division.

## Receiver Design

Another example of general purpose use of the 8901A is in the design of receivers. Because the Modulation Analyzer is a calibrated receiver it can simulate portions of prototype receivers. This is very useful in isolating problems. Take for example an FM receiver. If the audio output is distorted when an RF signal is applied at the antenna input, there is a question of which element may be causing the problem. The 8901A can monitor the signals at the points indicated by the arrows in Figure 2-8 to isolate the problem. At each point, the residual noise, AM content, FM content, signal level, and frequency is checked. Distortion can also be monitored with a distortion analyzer connected to the MODULATION OUTPUT. Thus, any element that causes AM to FM conversion, additional noise, or additional distortion is isolated.

## Extending the 8901A Frequency Range

The frequency range of the 8901A Modulation Analyzer is 150 kHz to 1300 MHz. This range can be extended higher using a spectrum analyzer as a fixed-tuned receiver and connecting the spectrum analyzer IF output to the Modulation Analyzer RF input. The spectrum analyzer should be in the linear detector mode and in zero span with a 3 MHz resolution bandwidth. This frequency translation technique permits the 8901A to make accurate modulation measurements on AM, FM, and  $\Phi$ M signals above 1300 MHz. Because the 8901A has very low noise, the measurement of residual FM is usually limited by the phase noise characteristic of the spectrum analyzer local oscillators. Other performance such as incidental AM or FM measurements may also be affected.

Another method of extending the frequency range is to use a mixer and local oscillator to down-convert the signal to be measured into the frequency range of the 8901A. The best performance results if the frequency input to the 8901A is between 10 MHz and 100 MHz.

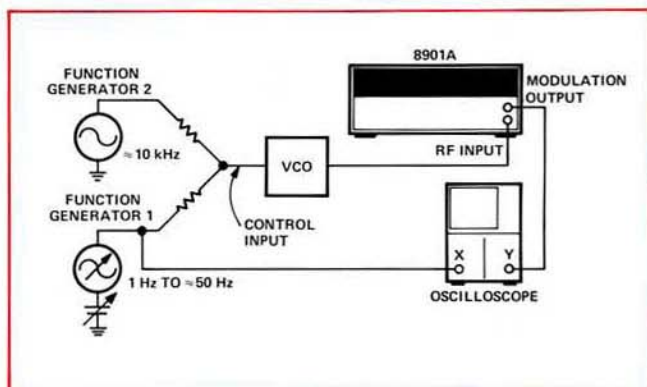

Figure 2-6. Equipment setup to measure real time VCO modulation sensitivity.

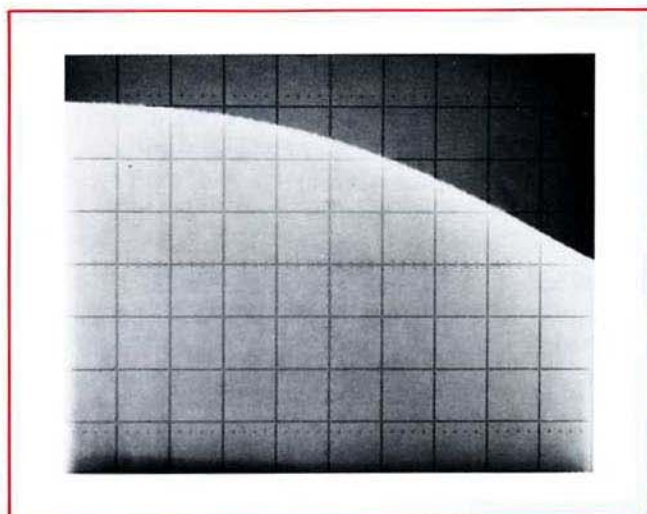

Figure 2-7. Real time display of modulation sensitivity.

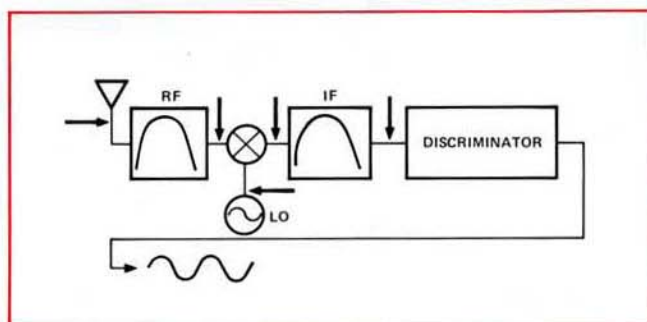
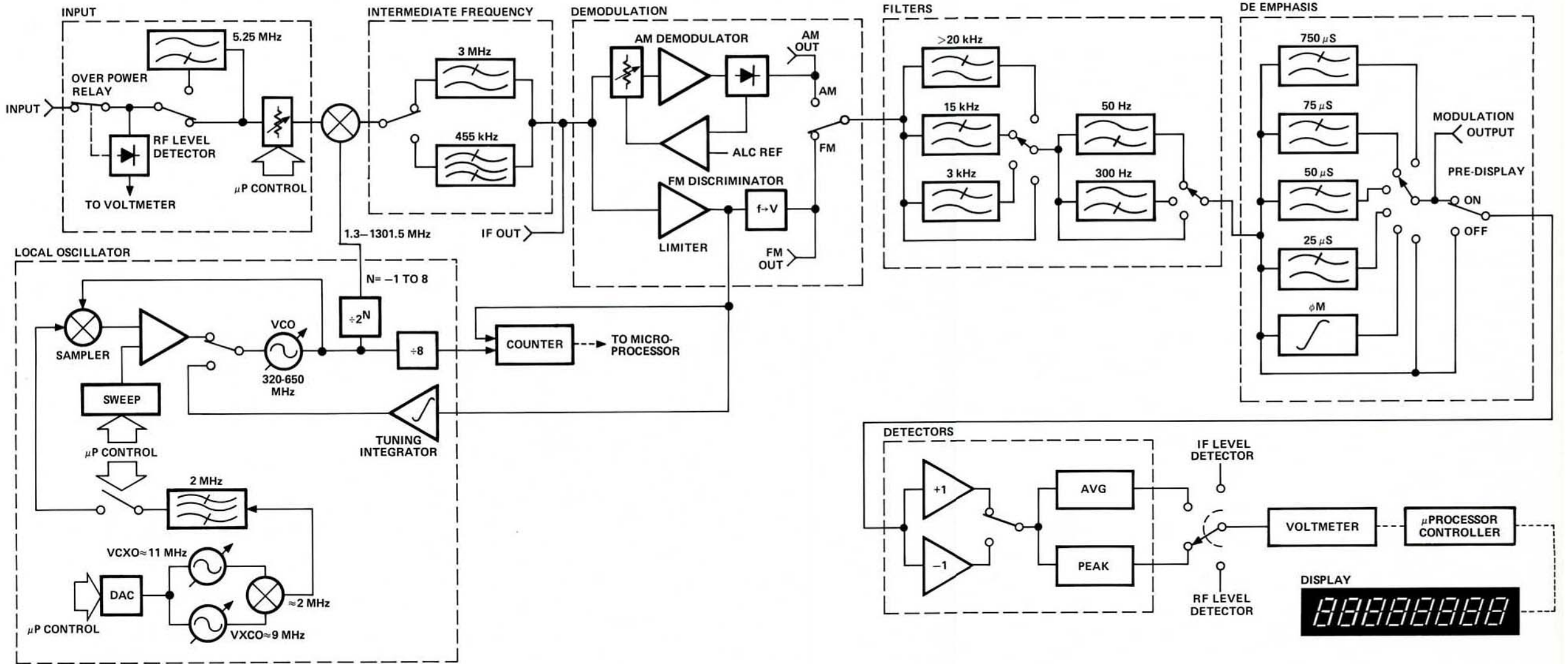

Figure 2-8. FM receiver design using the 8901A.



# 8901A Block Diagram





# Interior Layout



## 3. Theory of Operation

The 8901A Modulation Analyzer is most easily visualized as a calibrated, superheterodyne receiver. Like a receiver, it converts the incoming signal to a fixed intermediate frequency (IF) which is then demodulated and appropriately filtered. However, unlike most receivers, the Modulation Analyzer has no tuned RF amplification and the recovered modulation is measured and displayed rather than applied to an audio amplifier and speaker. A discussion of the signal flow in the 8901A follows. (Refer to block diagram.)

### Input

The signal at the RF input is sensed by the input diode detector. If the signal level exceeds one watt, the over-power relay opens immediately to protect the input circuits. For signal levels less than 1W the programmable attenuator sets the optimum level into the mixer. When RF level is being measured, the microprocessor determines the input power from the RF detector voltage and displays the result on the front panel. For signals above 10 MHz, the 5.25 MHz high-pass filter can be inserted to eliminate any extraneous signals, such as AM broadcast signals, that might otherwise pass through to the IF.

### Intermediate Frequency (IF)

The mixer and local oscillator (LO) convert the signal to the intermediate frequency (IF). The IF is normally 1.5 MHz for signals above 10 MHz and 455 kHz for signals between 2.5 and 10 MHz, but the user has the option of selecting the 455 kHz IF above 10 MHz. Selecting the 455 kHz IF increases selectivity but modulation rates and FM deviations are restricted. For signals below 2.5 MHz the input passes directly through the mixer without frequency conversion. The IF level is detected to make sure there is sufficient signal for the modulation measurement selected. The IF detector is also used for making tuned RF level measurements and for automatic tuning. The IF signal is buffered and available at a connector on the back panel.

### AM and FM Demodulators

The AM demodulator detects the instantaneous amplitude of the IF signal and separates the detected signal into its ac and dc components. The dc component controls an ALC amplifier preceding the AM detector to

maintain a constant average signal level to the detector. The ac component is the recovered amplitude modulation.

The first stage of the FM demodulator is the limiter which amplifies and limits the IF signal, removing any AM. The FM discriminator demodulates all angle modulation. Phase modulation is recovered by integrating the demodulated FM in the audio circuitry.

The limiter output can be counted by the internal counter to measure the IF frequency. In frequency mode the analyzer measures the input signal frequency by counting the LO and IF and displaying the difference between the two. Because of the large limiter gain it is possible to measure the frequency of very low-level input signals.

### Audio Filters

The post-detection bandwidth of the recovered modulation is determined by the high-pass and low-pass filters. These audio filters are independently selectable.

### De-emphasis

After filtering, the modulation signal passes through the de-emphasis block. This block is by-passed for AM signals.  $\Phi$ M is recovered by integrating the signal from the FM discriminator. For FM signals, either no de-emphasis or any one of four standard networks may be selected. These are single-pole, low-pass filters that attenuate high modulation rates. The de-emphasized modulation is available at the front panel MODULATION OUTPUT. With PRE-DISPLAY mode off, the analyzer measures and displays absolute FM deviation. With PRE-DISPLAY on, the deviation displayed is scaled by one of the de-emphasis filters to simulate the audio output of an FM receiver.

### Detectors

After de-emphasis the modulation signal passes through an inverting or non-inverting amplifier and is converted to a dc level by either the average or peak detector. The amplifiers allow the peak detector to measure either the positive or negative peak of the modulation waveform. The dc voltmeter measures the output from whichever detector is selected and the front panel displays the corresponding modulation. In PEAK HOLD mode the peak detector decay time constant is greatly increased and the front panel reading is updated only in the upwards direction.

## Local Oscillator

The local oscillator (LO) mixes with the input signal and converts it to the IF. The 8901A has three modes for tuning the LO frequency: manual keyboard entry, automatic track tuning, and automatic low-noise tuning. In manual mode the microprocessor adjusts the LO 1.5 MHz higher than the entered frequency (455 kHz for frequencies  $<10$  MHz). Because the 8901A employs fundamental mixing, the receive frequency is settable over the full frequency range of 150 kHz to 1300 MHz. In automatic track mode the analyzer frequency locks to the input signal. The LO tracks as the input signal frequency varies to maintain a constant IF. Normal operation uses the automatic low-noise tuning mode which phase locks the LO to a low noise, voltage-controlled crystal oscillator (VCXO). For both automatic modes the 8901A tunes to the input signal if the second and third harmonics are  $<-10$  dBc, all other signals are  $<-30$  dBc, and AM and FM are within specified limits. Track mode is discussed further in section 4. A discussion of automatic low noise tuning follows.

Automatic tuning is a two step process. First the input signal frequency is determined. Then the microprocessor adjusts the VCXO's and the 320-651 MHz VCO is phase-locked to the VCXO's. The 8901A searches for the input signal by sweeping the LO downward from 1301.5 MHz in octaves until a signal is detected in the IF. Then the LO is moved to check whether the signal is a second or third harmonic. Next the LO and IF are counted to determine the input signal frequency. Then the microprocessor tunes the 320-651 MHz VCO close to the desired frequency. The 320-651 MHz VCO is then phase-locked to a harmonic of the 2 MHz signal from the VCXO's and the divide number of the LO output is set. The microprocessor fine tunes the VCXO's to achieve the correct LO frequency. The result is a stable, low noise, LO signal for down-converting the input signal.

The low noise of the 2 MHz signal used to phase-lock the VCO is achieved by using two VCXO's which tune in opposite directions as the control voltage varies. This method allows the use of high Q oscillators with limited tuning ranges. The result is a spectrally pure 2 MHz signal of higher quality than would be possible using a single 2 MHz VCXO.

# 4. Performance and Operation

## Frequency Measurement

The 8901A measures input frequency automatically from 150 kHz to 1300 MHz for levels between 22mVrms and 7Vrms (12mVrms to 7Vrms for input frequencies <650 MHz). The internal configuration of the Modulation Analyzer in frequency mode is shown in Figure 4-1. The input frequency is measured by first counting the local oscillator and then the IF frequency. The input frequency  $F_{in}$  is calculated by  $F_{in} = F_{lo} - F_{if}$ . The accuracy is equal to the reference accuracy  $\pm 3$  counts. (Reference aging is  $<1 \times 10^{-6}$ /month,  $<1 \times 10^{-9}$ /day optional.)

In automatic mode the count time of the LO and the display resolution are adjusted by the microprocessor to produce approximately 3.6 readings/second. Resolution is 10 Hz for  $F_{in} \leq 18.5$  MHz, 100 Hz for  $F_{in} \leq 325$  MHz, and 1 kHz for  $F_{in} > 325$  MHz. Special function 7.1 provides increased resolution of 10 Hz for  $F_{in} < 1000$  MHz and 100 Hz for  $F_{in} \geq 1000$  MHz. Sometimes decreased resolution is desired when digit flickering becomes annoying and fine resolution is not important. Special function 7.2 sets the display resolution to 1 kHz for all input frequencies. Table 4-1 summarizes these resolution modes.

**Example:** To obtain maximum resolution when counting a 500 MHz signal, execute the following keystrokes:



**Example:** To return the 8901A to auto resolution mode clear the 7.1 special function by pressing either the green AUTOMATIC OPERATION key or executing



## High Sensitivity (0.22 mV) Count Mode

Keying in the approximate frequency of the desired signal (within  $\pm 50$  kHz) manually tunes the 8901A and improves the counter sensitivity. If error E01 (signal out of IF range) is disabled with the 8.1 special function the frequency may be entered within  $\pm 1$  MHz of the desired signal. In this mode the Modulation Analyzer typically counts signals over a 90 dB dynamic range from 0.22 mVrms to 7Vrms ( $-60$  to  $+30$  dBm). The high sensitivity

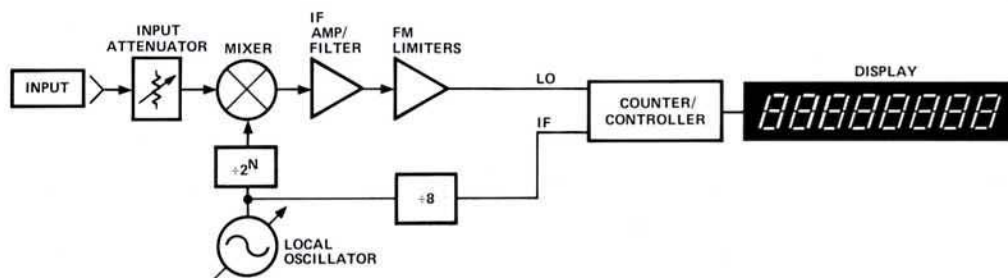

Figure 4-1. Input frequency measurement block diagram.

Table 4-1. 8901A frequency resolution modes.

Mode	Special Function	Resolution	Readings/Second*
Auto	7.0	10 Hz, $F_{in} < 18.5$ MHz 100 Hz, $F_{in} < 325$ MHz 1 kHz, $F_{in} > 325$ MHz	$>3.6$ $>3.6$ $>3.6$
High Resolution	7.1	10 Hz, $F_{in} < 1000$ MHz 100 Hz, $F_{in} > 1000$ MHz	$>1$ $\leq 1$
Low Resolution	7.2	1 kHz, for all $F_{in}$	$\geq 5$

\* The first reading may take up to 2 seconds (typically 1.3) because the 8901A must tune to the input signal.

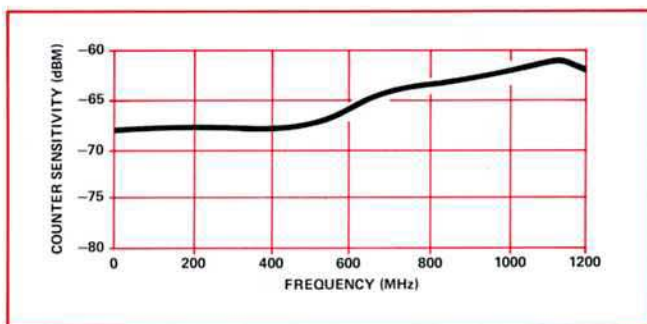

Figure 4-2. Typical 8901A counter sensitivity when manually tuned.

is due to the large IF gain, and the wide dynamic range results from 50 dB of attenuation automatically adjusted by the microprocessor. If the input signal level is too low to count the 8901A displays a single zero. Figure 4-2 shows typical performance in the high sensitivity count mode.

**Example:** To count a 0.5 mV signal near 450.52 MHz, key in



Note: It is only necessary to set the frequency within 50 kHz. Automatic operation is resumed by pressing the green AUTOMATIC OPERATION key.

## Amplitude Modulation Measurement

In AM mode the 8901A automatically measures percent depth with accuracy of 1% of reading  $\pm 1$  count to depths up to 99%. The internal configuration of the Modulation Analyzer in AM mode is shown in Figure 4-3. The analyzer measures AM as the ratio of the demodulated audio signal level to the average tuned carrier level. The ALC loop within the demodulator holds

the carrier level  $E_{avg}$  constant so that the percent AM is proportional to the amplitude of demodulated audio output. This output is filtered, detected, and displayed as % AM. The 8901A measures  $E_{max}$  or  $E_{min}$  depending on whether the PEAK+ or PEAK- detector is selected (Figure 4-4). The peak positive  $m_+$  or negative  $m_-$  percent AM is then computed and displayed using the formulas in Table 4-2.

When the AVG detector is selected, the demodulated audio signal amplitude  $V_{rms}$  is measured with an average responding detector that is rms calibrated for a sine wave. The percent AM displayed is computed using the formula in Table 4-2. Notice that for a sinusoidal modulation

**Table 4-2.** Internal 8901A amplitude modulation formulas.

Detector	Percent Modulation Formula
PEAK +	$m_+ = \frac{E_{max} - E_{avg}}{E_{avg}} \times 100$
PEAK -	$m_- = \frac{E_{avg} - E_{min}}{E_{avg}} \times 100$
AVG	$m = \frac{V_{rms}}{E_{avg}} \times 100$

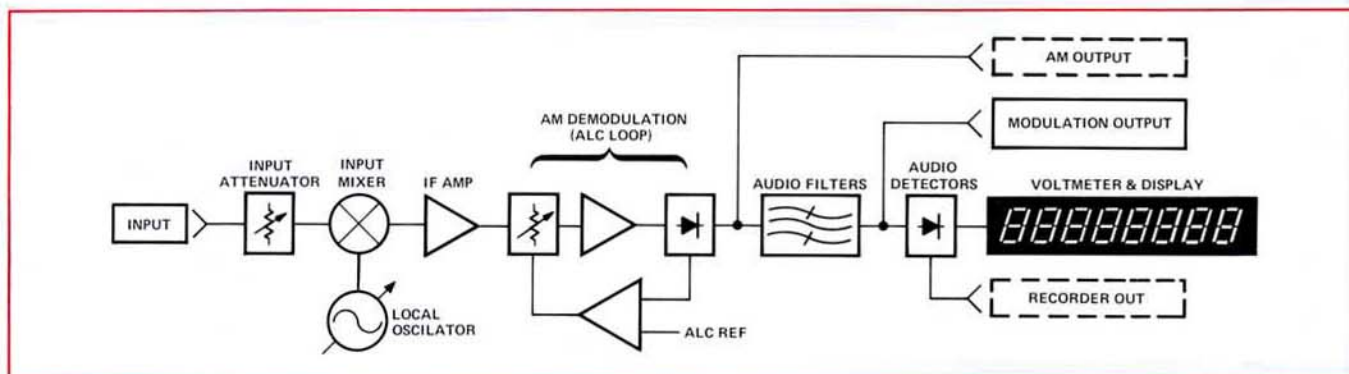

**Figure 4-3.** AM measurement block diagram.

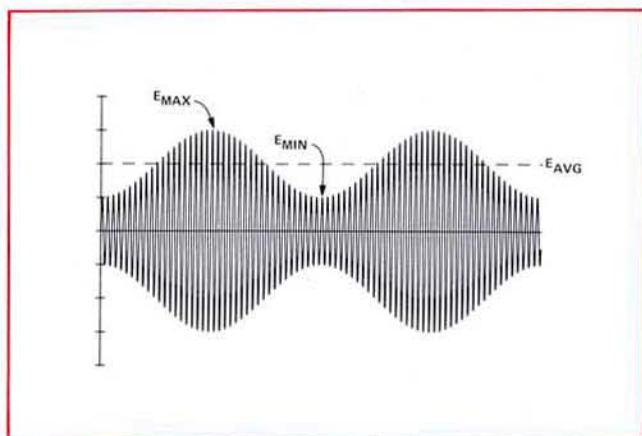

**Figure 4-4.** RF carrier modulated with 50% AM.

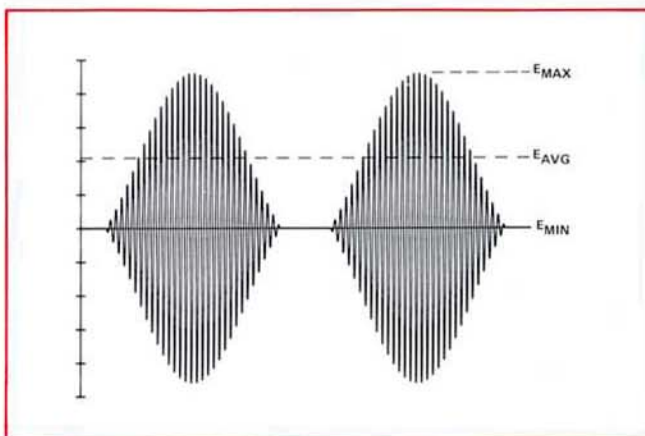

**Figure 4-5.** RF carrier modulated with 130% AM.

signal the percent AM displayed using the PEAK detector is 1.41 times that using the AVG detector since  $E_{\max} - E_{\text{avg}} = \sqrt{2} V_{\text{rms}}$ .

### Measuring AM Depths Greater than 100%

Often it is desired to measure percent AM for depths greater than 100%. Peak positive depths greater than 100% occur whenever the peak  $E_{\max}$  is greater than twice the average level  $E_{\text{avg}}$  (Figure 4-5). The 8901A measures peak positive AM depth to greater than 300% with typical accuracy better than 3% of reading.

For AM depths greater than 100% the RF carrier may be pinched off for a portion of the negative half cycle of the modulating waveform. The theoretical limit from Table 4-2 for negative AM depth,  $m_-$ , is 100 because  $E_{\min} = 0$  when the carrier is pinched off. The 8901A displays very close to 100 with the PEAK- detector selected. The Modulation Analyzer may lose "lock" on the input signal in automatic operation because the carrier level is pinched off. Fortunately, this problem is easily overcome using the manual tune mode by pressing the MHz key while the analyzer is properly tuned to the input signal. If the 8901A is not already tuned to the input signal, key in the frequency of the input signal. For example, if the frequency is 30.1 MHz the keystrokes required are



It may also be necessary to override errors with

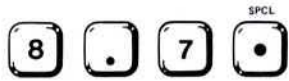

### AM Flatness

AM flatness is very important in testing instrument landing system (ILS) transmitters. Figure 4-6 shows the typical AM flatness for low modulation rates. Between 90 Hz and 150 Hz rates the variation in flatness is typically better than 0.03%. For best flatness and repeatability it's helpful to average 10 readings. The slow peak detector time constant (special function 5.1) is also recommended.

## Frequency Modulation Measurement

In FM mode the 8901A automatically measures the deviation to 1% accuracy for rates 20 Hz to 100 kHz. Figure 4-7 shows the internal configuration of the 8901A in FM mode. The analyzer displays the peak deviation from the average carrier frequency in kHz. The peak detectors allow either the positive or negative peak deviation to be measured.

### Carrier Shift

When the modulating signal applied to an FM transmitter contains a non-zero dc component it causes a shift in the average carrier frequency. Carrier shift can be measured with the 8901A by measuring the transmitter frequency with and without the modulation signal applied. The difference represents the frequency shift from the unmodulated carrier. Another way to measure carrier shift is to manually enter the unmodulated carrier frequency. Then the 8901A displays the carrier shift of the modulated signal in frequency error mode. This difference can also be added to the peak deviation displayed to obtain the peak frequency deviation from the unmodulated carrier.

### Residual FM

Low residual FM is one of the key contributions of the 8901A. Figures 4-8 and 4-9 show the residual FM of the 8901A for various post detection bandwidths. Note that the residual FM is significantly reduced when the 15 kHz

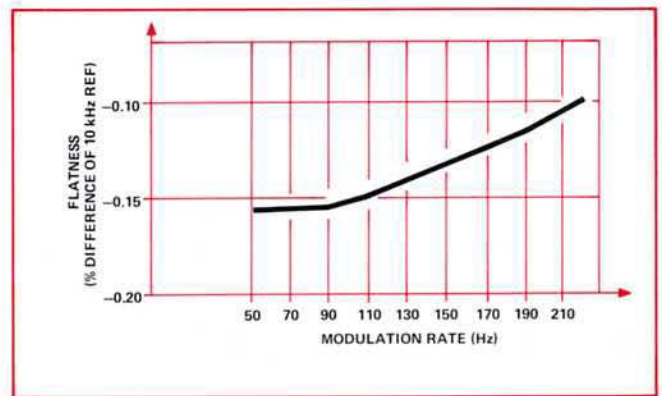

Figure 4-6. Typical AM flatness when averaging 10 readings (20 to 80% AM depth).

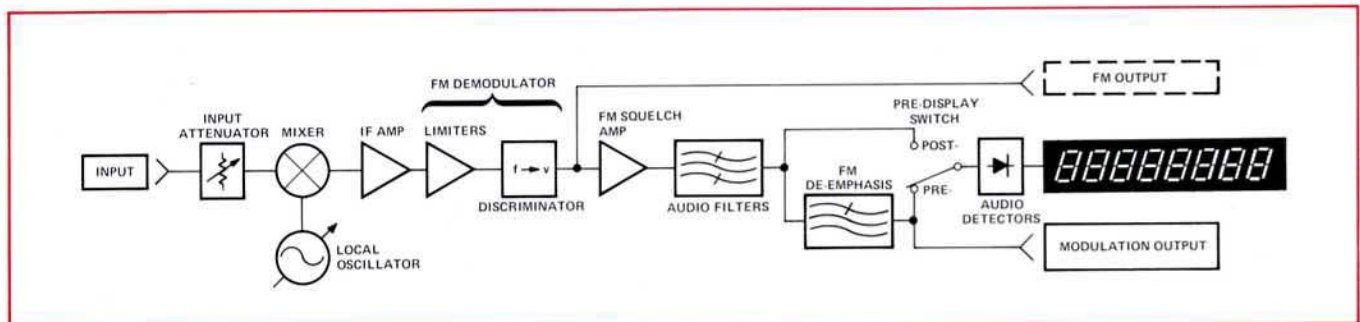

Figure 4-7. FM measurement block diagram.

and 3 kHz low-pass filters are used to restrict the measurement bandwidth. High-pass filters have little effect on the internal 8901A residual FM. The average responding detector (rms sinewave calibrated) is used to obtain the data in Figure 4-8 because the rms value of the residual noise is generally more desirable than the peak value.

For mobile transmitters residual FM is often expressed as hum and noise referred to a 1 kHz rate and a 3 kHz

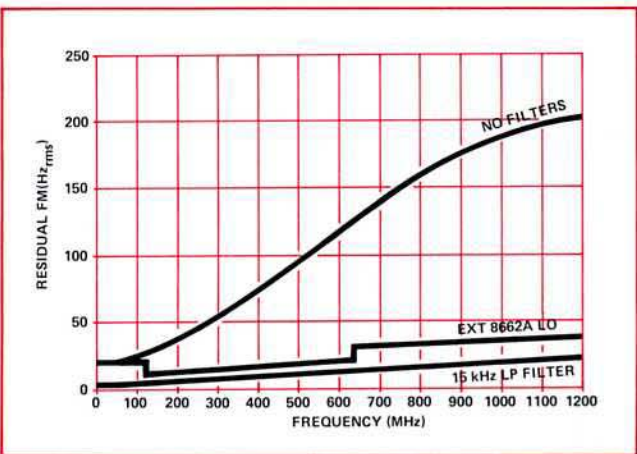

Figure 4-8. Typical 8901A residual FM.

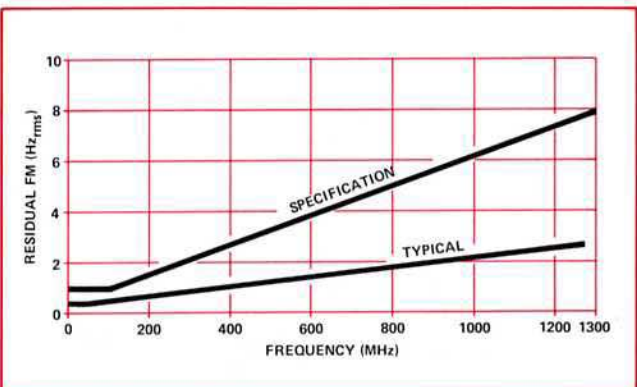

Figure 4-9. 8901A residual FM (50 Hz to 3 kHz BW).

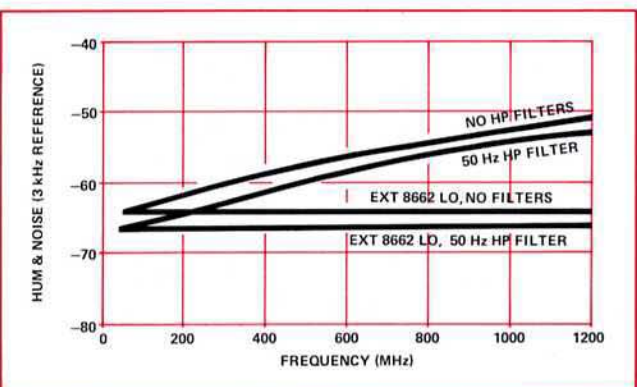

Figure 4-10. Typical 8901A hum & noise (750 μs pre-display mode).

peak deviation. Figure 4-10 shows the typical 8901A hum and noise. The analyzer settings were FM mode, 750 μs pre-display de-emphasis, average detector, and dB ratio mode with a ratio reference of 0.440 (section 2 describes how to make hum and noise measurements in greater detail). Best hum and noise performance is achieved using the 50 Hz high-pass filter. For best hum and noise performance for high frequencies, the HP 8662A Synthesized Signal Generator can be used as a local oscillator.

**Frequency-Shift Keying**

Frequency-shift keying (FSK) is a popular digital modulation format used with FM transmitters. The 8901A contains a special post detection filter for accurately measuring FSK modulation. The >20 kHz filter is a nine pole Bessel low-pass filter. It minimizes overshoot on squarewave modulation typically to less than 1%.

Figure 4-11 is an oscillograph of the 8901A MODULATION OUTPUT for an RF test signal modulated by a 10 kHz squarewave to 5.0 kHz peak deviation. The ringing is due to the audio circuitry of the 8901A. The peak detector catches the peak of the ringing and indicates 6.61 kHz peak deviation. In Figure 4-12 the ringing is eliminated using the >20 kHz low-pass filter and the 8901A indicates the peak deviation correctly as 5.0 kHz.

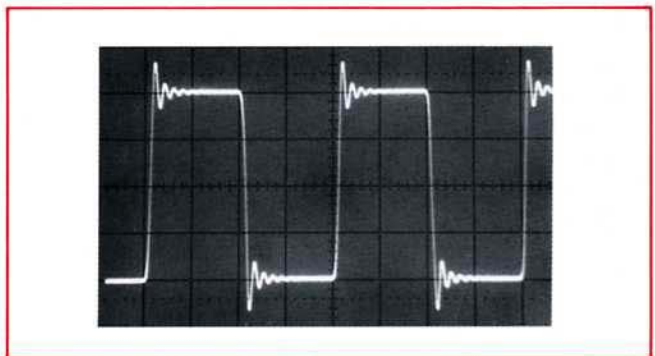

Figure 4-11. Demodulated 10 kHz FSK signal without >20 kHz low pass filter.

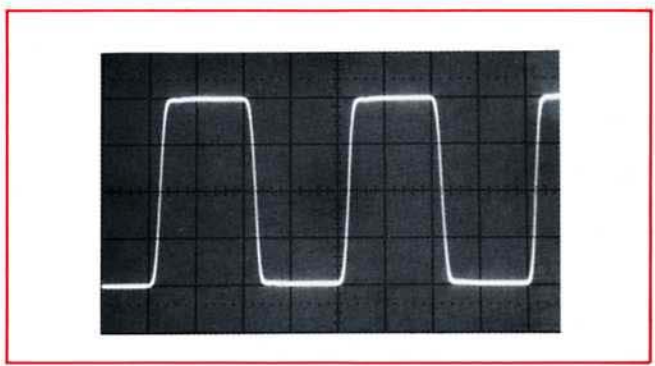

Figure 4-12. Demodulated 10 kHz FSK signal with >20 kHz low pass filter.

## Stereo Separation

The 8901A accurately recovers FM stereo modulation for making measurements such as stereo separation (Figure 4-13). The left and right channels of stereo FM broadcast signals can be obtained by connecting a stereo decoder to the modulation output. Figure 4-14 shows typical 8901A stereo separation as audio rate is varied.

## Accounting for Peak Residuals

To realize the maximum accuracy of the 8901A when making peak modulation measurements it is necessary to account for peak noise residuals. With the input RF signal modulated the 8901A measures the peak of the signal plus noise  $(S + N)_{pk}$ . The noise peak  $N_{pk}$  is measured by turning off the modulating signal to the signal generator or transmitter under test. Unfortunately, the true peak  $S_{pk}$  cannot be computed directly by subtracting  $N_{pk}$  from  $(S + N)_{pk}$ . The effect of the noise contribution  $N_{pk}$  on the total signal  $(S + N)_{pk}$  measured by the peak detector varies with the waveform shape and signal-to-noise ratio  $(S + N)_{pk}/N_{pk}$  of the modulating signal. For the special case of the calibrator output, the 8901A automatically compensates for the peak residual and the weighted residual peak modulation can be displayed using the 12.1 or 13.1 special functions for FM or AM. This is not possible for other input signals since the modulating waveform is arbitrary.

For sinusoidal modulation the nomograph in Figure 4-15 can be used to subtract the appropriate percentage of noise  $N_{pk}$  to obtain the true peak of  $S_{pk}$ . The following procedure and example illustrate the use of the nomograph.

1. Set up the measurement and read the  $(S + N)_{pk}$  from the display. This may be noisy so gauge the correct reading visually. If any low pass filters are on, leave them on for the remainder of this procedure.
2. Freeze the modulation range using the 9.0 special function.
3. Turn off the modulating signal and measure the average noise  $N_{avg}$  using the average detector.
4. Measure the peak noise  $N_{pk}$  with the peak detector.

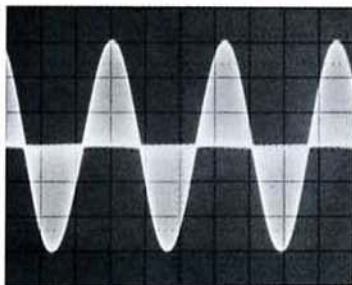

Figure 4-13. Demodulated 15 kHz FM stereo test signal.

5. Compute  $(S + N)_{pk}/N_{pk}$  and  $N_{pk}/N_{avg}$  and use the nomograph to calculate the percentage,  $N\%$ , of  $N_{pk}$  to subtract from  $(S + N)_{pk}$ .
6. Compute the true peak,  $S_{pk}$ , using the formula
 
$$S_{pk} = (S + N)_{pk} - (N\%)(N_{pk})$$

**Example:** The following example shows how the procedure might be used to precisely measure AM depth of a signal generator set to 30% AM.

1. The peak modulation using the 15 kHz low pass filter is measured.



Result: 30.15%

2. The modulation range is frozen by pressing



3. The modulation is turned off and the noise is measured:



Result: 0.02%

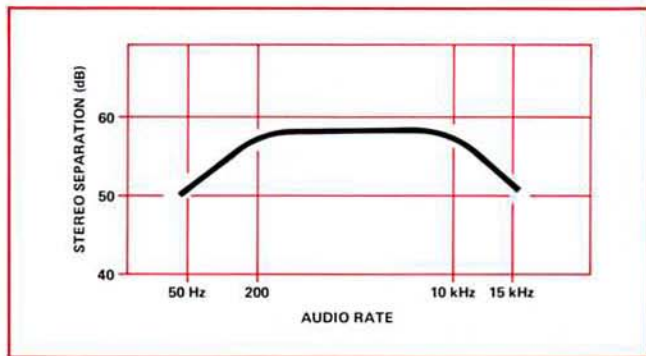

Figure 4-14. Typical 8901A stereo separation.

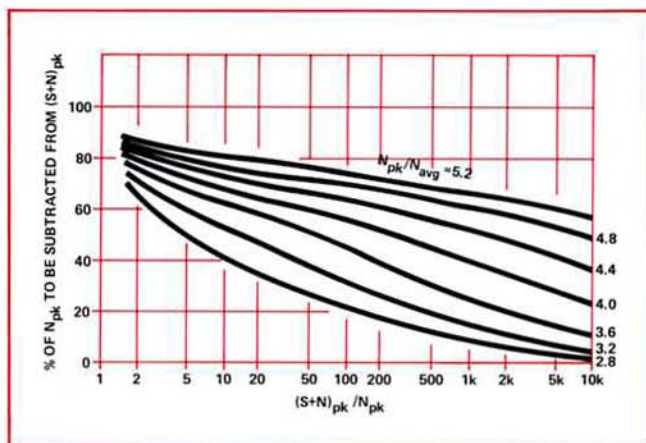

Figure 4-15. Nomograph for  $N\%$  to calculate the true peak  $S_{pk}$ .



4. To simplify computing the ratio  $N_{pk}/N_{avg}$ , ratio mode is used:



Result: 300%

$N_{pk}/N_{avg}$  is 3.

5. The noise peak  $N_{pk}$  is measured:



Result: 0.06%

6.  $(S + N)_{pk}$  is computed to be 502.5 since

$$\frac{N_{pk}}{N_{pk}} = 502.5$$

$$\left(\frac{30.15}{0.06}\right) = 502.5$$

and the percentage  $N\%$  to be subtracted from  $N_{pk}$  is obtained from the nomograph (Figure 4-15).

Result:  $N\% = 15\%$

7. Therefore, the true peak is 30.14%, not 30.15%.

$$= 30.15 - (0.15)(0.06)$$

$$= 30.14$$

## RF Level Measurement

The 8901A measures peak broadband RF power over the range 0 to +30 dBm (1 mW to 1W). The internal configuration of the Modulation Analyzer in RF LEVEL mode is shown in Figure 4-16. A diode detector senses the broadband RF power at the input. The internal voltmeter measures the detector output and the microprocessor converts the result to watts. Since the

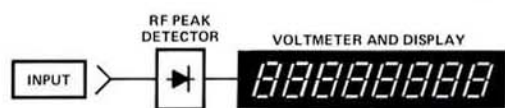

Figure 4-16. RF level measurement block diagram.

diode is a peak detector, the 8901A measures peak envelope power (PEP) and may be used to measure single sideband transmitter power. A plot of typical level accuracy as a function of RF input frequency is shown in Figure 4-17.

## Reverse Power Protection

Since the 8901A is often connected to transmitters either directly or through an attenuator, the possibility of accidental application of too much power is quite real. To guard against damage to the 8901A a diode detector continuously monitors input signal levels. If the input level exceeds 1 watt (+30 dBm) the power protect relay automatically opens. The input protection is conservatively rated at 25 watts; however, the relay typically withstands overloads up to 100 watts. When an input overload occurs the display indicates the error message "EO6". Normal instrument operation resumes after any key is pressed and the overload condition is no longer present. In remote operation the analyzer requests service if desired. The remote operation section contains an example which illustrates recovering from errors in the event of an overload condition.

## Tuned RF Level Measurement

In the TUNED RF LEVEL mode the Modulation Analyzer measures the peak RF level in the IF section for RF input levels in the range 10 nW to 1 W (-50 to +30 dBm). The internal configuration in TUNED RF LEVEL mode is shown in Figure 4-18.

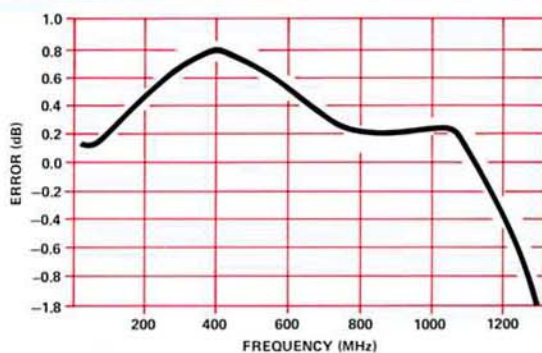

Figure 4-17. Typical 8901A RF level accuracy.

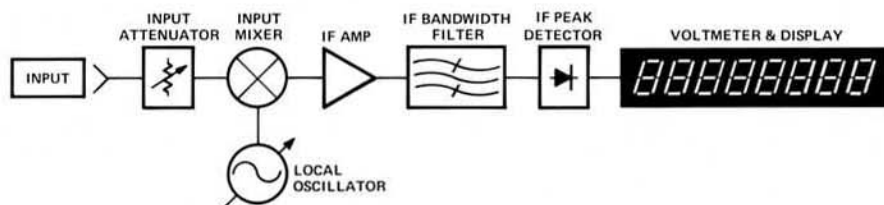

Figure 4-18. Tuned RF level measurement block diagram.

The measurement bandwidth is determined by the IF filter bandwidth. Either the 455 kHz filter or the 1.5 MHz filter may be selected using special functions 3.1 or 3.2, respectively. Figure 4-19 shows the portion of the spectrum to which the 8901A responds for each of the two possible IF bandwidths. Note that since the 8901A doesn't have tuned RF amplification, no image rejection is provided. However, many useful selective RF level measurements can be made in the presence of other undesired signals. In particular, for signals separated by more than 200 kHz, RF level can often be measured independently using the 455 kHz IF filter.

### Measuring Carrier Harmonics

Tuned RF level mode is most useful in making relative power measurements. Typically, the 8901A can measure carrier harmonics to  $-50$  dBc or a minimum absolute level of  $-50$  dBm, with  $\pm 2$  dB accuracy ( $\pm 3$  dB for frequencies  $>300$  MHz).

**Example:** Measure the 2nd harmonic of a 100 MHz transmitter (or signal generator at 100 MHz, +10 dBm).

Execute the following:

1. Select TUNED RF LEVEL mode.

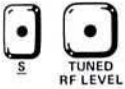

2. Select 455 kHz IF.



3. Disable automatic error display.



4. Manually tune the analyzer to the transmitter frequency.

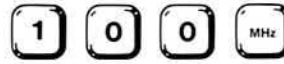

5. Manually tune the analyzer 100 kHz lower. This positions the signal at the 3 dB point of the 455 kHz IF filter and minimizes the effect of local oscillator related spurious products in the IF.



6. Establish the carrier reference. The display now reads 0.00.



7. Tune 100 kHz below the second harmonic. Note that the increment value need not be repeated because it remains constant until changed.



The display now indicates the 2nd harmonic level in dBc.

### IF Level Mode

In IF level mode, the 8901A monitors the dc output of the AM detector after the automatic gain control amplifier (AGC) and displays it as a percent of the optimum level (Figure 4-20). Normally, in automatic operation the analyzer displays either 100%, indicating sufficient signal strength to guarantee accurate

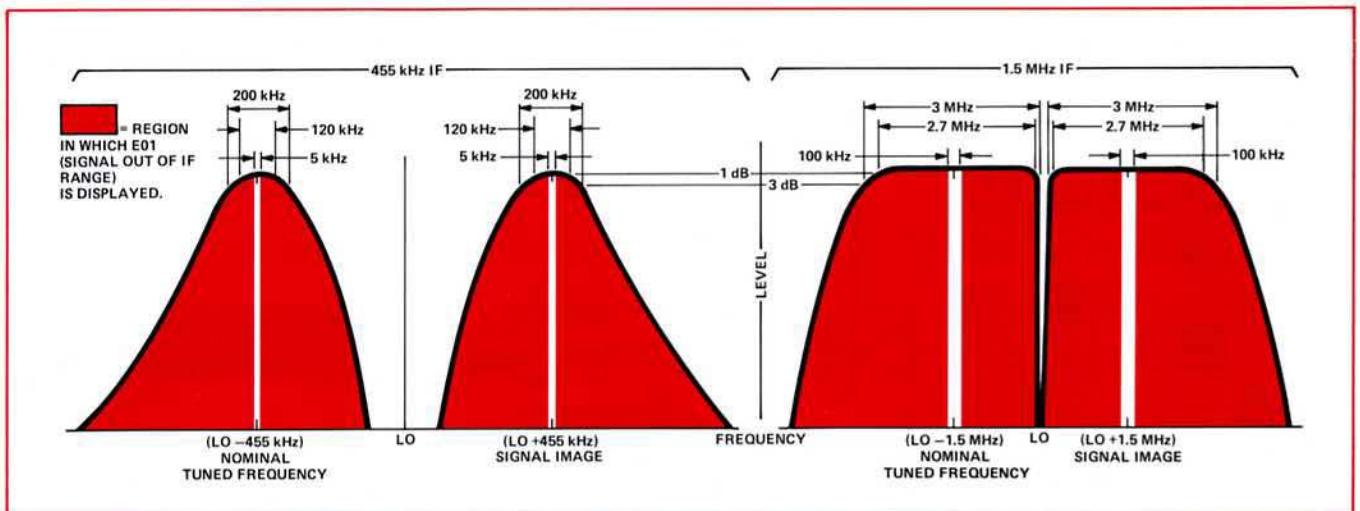

Figure 4-19. Typical 8901A IF bandwidth characteristics.

modulation measurements, or two dashes indicating that the analyzer cannot automatically tune to the input signal. However, if the analyzer is manually tuned the IF level can drop below 100%. A display of less than 100% means that the AGC amplifier has reached maximum gain (about 14 dB) and it still cannot provide the optimum signal level.

**High Sensitivity FM Measurements**

Certain applications such as off-the-air FM monitoring, require higher sensitivity than the -25 dBm the 8901A provides in automatic operation. For these applications meaningful FM measurements to -50 dBm are possible by manually tuning the 8901A and disabling error E03 (input circuits underdriven) with the 8.2 special function. The IF level can be used as a figure of merit for judging the validity of these measurements.

**High Sensitivity AM Measurements**

AM measurements can also be made to approximately -40 dBm. However, because AM measurements are proportional to (IF Level %)/100, the AM displayed changes as the IF level drops below 100%. The following procedure corrects for this:

1. Manually tune the 8901A to the desired frequency. For example, if the frequency is 35.3 MHz, the keystrokes are



2. Disable error E03 with

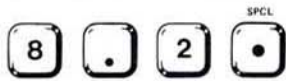

3. Measure the IF level and establish a ratio reference by keying



4. Select AM mode and scale measurements by the IF level reference.



The 11. special function re-enters % RATIO mode with the previous reference. This is necessary because RATIO is disabled when the measurement mode changes from IF Level to AM. The analyzer now displays AM depth correctly in percent. This procedure must be repeated if the input level changes.

**AM Measurements Relative to the Unmodulated Carrier**

The IF level mode may also be used with the AGC disabled to make AM measurements relative to the unmodulated carrier. The procedure is:

1. With the carrier unmodulated disable the AGC and establish an IF level reference

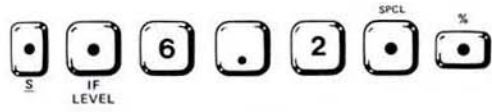

2. Turn on the amplitude modulation and key in



The analyzer now displays AM depth in percent relative to the unmodulated carrier. This procedure must be repeated if the input level changes because the AGC leveling is defeated.

**Track Mode**

Track mode is enabled using the 4.1 special function. In this mode the 8901A automatically tunes to the input signal. However, it does not lock to the voltage controlled crystal oscillators (VCXOs) as in automatic operation. Instead it frequently locks to the input signal as shown in Figure 4-21. The FM discriminator output is used as an error signal to adjust the local oscillator frequency. Thus, the 8901A stays tuned as the input signal frequency varies.

Track mode is useful in applications where the input frequency is changing. One application is measuring modulation flatness of signal generators as center frequency is varied. Another application is measuring modulation sensitivity (linearity) of voltage-controlled oscillators (VCOs). A small amplitude sinewave (~10 kHz) is combined with a low frequency sinewave (<60

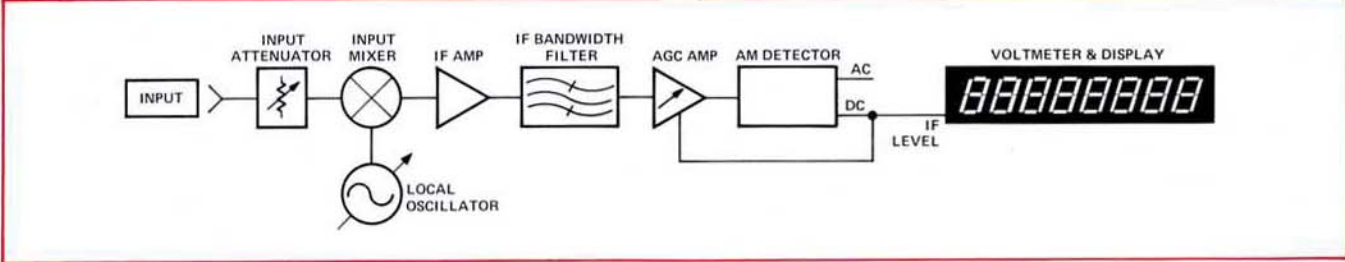

Figure 4-20. IF level measurement block diagram.

Hz) of larger amplitude and applied to the control input of the VCO. The small sinewave produces a reference FM deviation while the other varies the VCO center frequency. Track mode allows the 8901A to continue measuring FM while tracking the VCO. The 8901A can track VCOs in real time over a much greater frequency range than has been possible before. VCO linearity testing is covered in more detail in section 2.

AM measurements are essentially unaffected in track mode. However, for best FM measurement results several recommendations should be followed. First, the modulation rate should be 1 kHz or greater. This is because the track loop attenuates low rate FM as it tracks the input signal. FM accuracy is typically degraded 1% at 1 kHz and progressively less as rate increases. At a 10 kHz rate there is essentially no degradation due to the track loop. Second, the average responding detector is recommended in track mode. The average detector is less sensitive than the peak detectors to undesired FM deviation transients. Such transients are caused by discontinuities in the rate of change of the input signal frequency. For example, if the frequency tuning knob of a signal generator is turned in a jerky motion, large apparent peak deviations can result. The average detector smooths out these transients. Third, the residual FM degrades slightly in track mode typically to 12 to 20 Hz in a 3 kHz bandwidth for input frequencies less than 650 MHz. Much of the increase is due to 60 Hz line effects in the track loop. These line effects can be significantly reduced by selecting the 300 Hz high-pass filter. Residual FM is typically 3 to 11 Hz (300 Hz to 3 kHz bandwidth) for frequencies up to 650 MHz. Finally, auto-track should be used *within* the frequency bands listed in Table 4-3. The reason is that at the band limits frequency lock is broken and the search and lock cycle is repeated. Retuning can take as long as two seconds. Consequently, if the input frequency is changing rapidly, the 8901A may not be able to retune. The lowest frequency at which track mode can be used is 10 MHz.

**Table 4-3.** 8901A Continuous track mode bands.

Lower Band Edge (MHz)	Upper Band Edge (MHz)
10	18.8
18.5	39.2
38.5	79.9
78.5	161.2
158.5	324.0
318.5	649.5
638.5	1300

**Table 4-4.** 8901A IF and input filters.

IF Frequency (MHz)	Input High-Pass Filter	Special Function Code
Automatic IF frequency selection 0.455	Out	3.0 SPCL
1.5	Out	3.1 SPCL
0.455	In	3.2 SPCL
1.5	In	3.3 SPCL
	In	3.4 SPCL

## IF Filter Characteristics

The 8901A has two IF filters. One is 200 kHz wide (3 dB points) centered at 455 kHz and the other is 3 MHz wide with a 1.5 MHz center frequency. Figures 4-22 and 4-23 show the typical transfer characteristics of the IF filters. In automatic operation the 1.5 MHz filter is selected for input frequencies below 2.5 MHz or above 10 MHz, and the 455 kHz filter is selected for inputs between 2.5 and 10 MHz. Either filter may be selected manually using the special functions in Table 4-4.

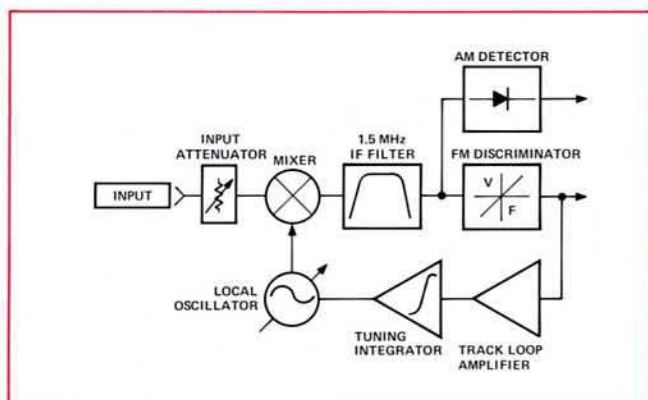

**Figure 4-21.** Track mode block diagram.

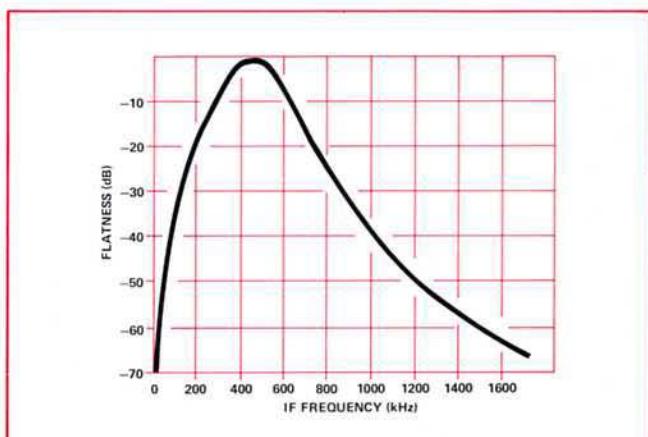

**Figure 4-22.** 455 kHz IF filter characteristic.

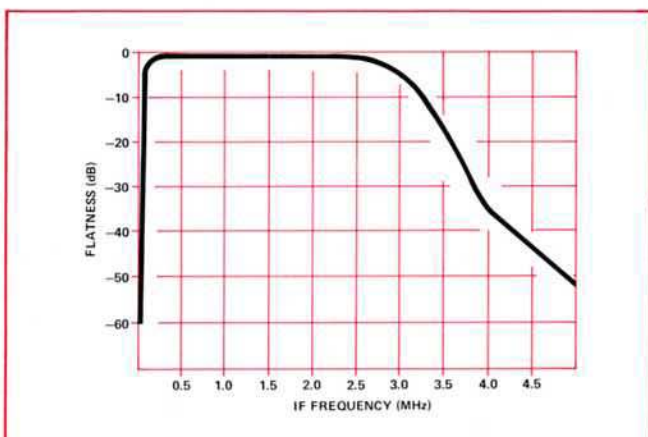

**Figure 4-23.** 1.5 MHz IF filter characteristic.

In addition to the IF filters, a 5.25 MHz high-pass input filter can be selected. Because the input mixer does not reject low frequency signals, extraneous signals such as AM broadcast pickup could affect measurements. These undesired low frequency signals can be rejected using the high-pass filter for measurements being made above 10 MHz.

## Audio Filter Characteristics

The audio filters determine the post detection measurement bandwidth of the signals applied to the peak or average detectors. The 50 and 300 Hz high-pass filters are useful in filtering out hum and low frequency noise. The 3 kHz and 15 kHz low-pass filters reduce the effects of high frequency noise and are especially useful in making residual AM or FM measurements. The high-pass filters are two-poles and the low-pass filters are five-poles. This ensures sharp cutoffs yet allows testing at a 1 kHz rate to remain essentially unaffected. The >20 kHz low-pass filter is a nine-pole Bessel filter designed for minimum overshoot (ringing) on square wave modulation

such as frequency shift keying (FSK). The transfer characteristics shown in Figures 4-24 through 4-28 were obtained using the 8901A in ratio mode while varying the modulation rate.

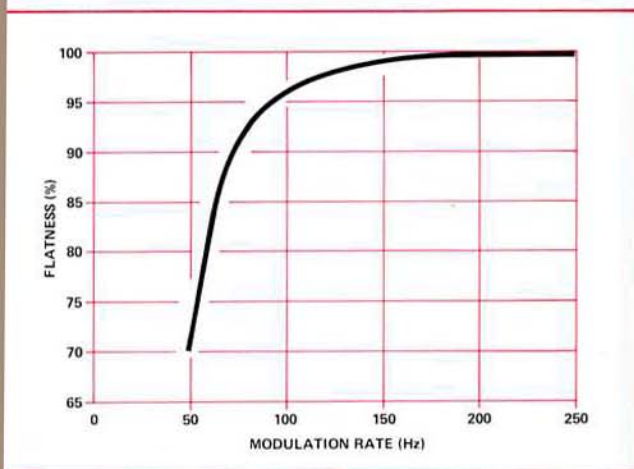

Figure 4-24. Typical 50 Hz high-pass filter response.

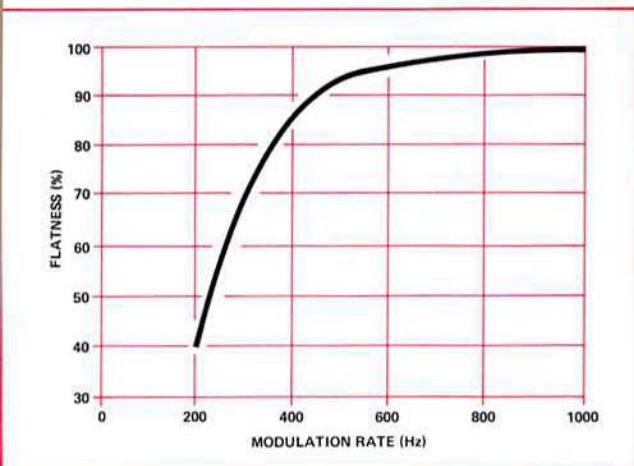

Figure 4-25. Typical 300 Hz high-pass response.



Figure 4-26. Typical 3 kHz low-pass filter response.

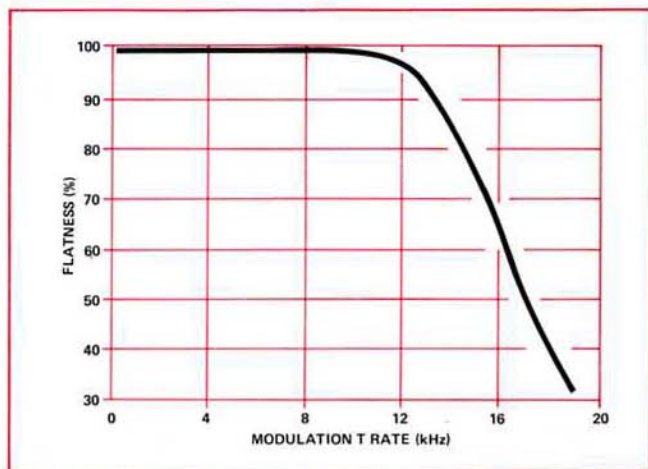

Figure 4-27. Typical 15 kHz low-pass filter response.

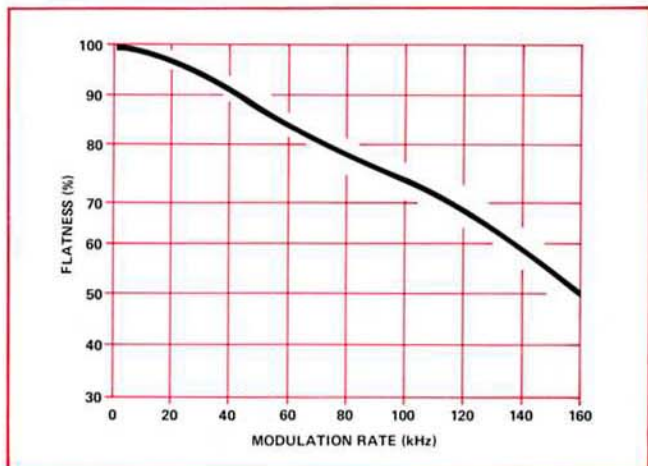

Figure 4-28. Typical >20 kHz low-pass filter response.

## Peak Hold Detector

PEAK HOLD may be selected with either the positive (PEAK +) or negative (PEAK -) peak detector. In this mode the peak detector decay time constant is greatly increased and the displayed modulation is updated only in an increasing direction. Peak hold is ideal for detecting short modulation transients. For fast single transients less than 1 ms duration the peak hold detector captures approximately 90% of the true peak. If the transient is repeated after 10 ms the peak hold detector captures 90% of the new difference or 99% of the true peak. Therefore, it is recommended that the peak-generating process be repeated several times where possible.

## Special Function Operation

Most measurements with the 8901A require only a single keystroke. There is no need to tune, adjust levels, or select the appropriate range because the microprocessor determines the optimum instrument settings automatically. However, in some applications it is desirable to override the automatic selection. Special functions provide manual control of instrument functions. There are eight groups of commonly used instrument control special functions (see Table 4-5). Special function modes are accessed by entering the appropriate code (prefix, decimal point, suffix) and then pressing the SPCL key. Pressing the SPCL key without entering a number causes the analyzer to shift to an eight digit status display. The digit position is the special function prefix and the displayed number is the suffix corresponding to the desired instrument setting. For example, if the modulation range is manually set to the 400 kHz FM range with the 2.3 special function, the status display shows a three in the second digit (Figure 4-29). The special display contains zeroes for the functions in automatic selection. The user can select any combination of manual or automatic operation. Pressing the SPCL key twice without entering a number causes the display to show the current instrument settings, including settings which have been automatically set by the microprocessor.

Besides providing manual control, special functions are used to set upper or lower limits, enable service requests, verify accuracy of other 8901A's not fitted with the calibrator option, and to troubleshoot the 8901A if a failure occurs.

The 14.2 special function sets the upper limit to the current ratio reference. For example, to establish 75 kHz as the upper deviation limit when the analyzer is in FM mode the keystrokes are

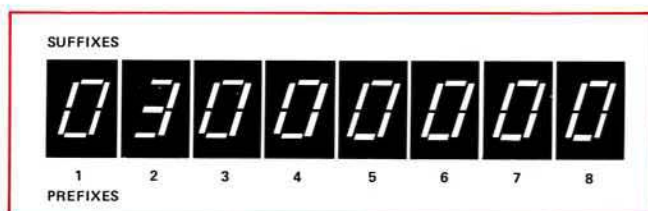

Figure 4-29. 8901A special function status display.

Table 4-5. 8901A manual control special functions.

Function	Code	Description												
Input Attenuation	1.0	Automatic selection												
	1.1	0 dB input attenuation												
	1.2	10 dB input attenuation												
	1.3	20 dB input attenuation												
	1.4	30 dB input attenuation												
	1.5	40 dB input attenuation												
Modulation Range	2.0	Automatic selection												
		<table border="1"> <thead> <tr> <th>AM (%)</th> <th>FM (kHz)</th> <th>DM (rad)</th> </tr> </thead> <tbody> <tr> <td>≤ 40</td> <td>≤ 4</td> <td>≤ 0.4*</td> </tr> <tr> <td>≤ 100</td> <td>≤ 40</td> <td>≤ 4*</td> </tr> <tr> <td>≤ 100</td> <td>≤ 400</td> <td>≤ 40*</td> </tr> </tbody> </table>	AM (%)	FM (kHz)	DM (rad)	≤ 40	≤ 4	≤ 0.4*	≤ 100	≤ 40	≤ 4*	≤ 100	≤ 400	≤ 40*
	AM (%)	FM (kHz)	DM (rad)											
	≤ 40	≤ 4	≤ 0.4*											
	≤ 100	≤ 40	≤ 4*											
	≤ 100	≤ 400	≤ 40*											
2.1	≤ 40	≤ 4												
2.2	≤ 100	≤ 40												
2.3	≤ 100	≤ 400												
		*with 750μs de-emphasis and pre-display												
IF Frequency and Input High-Pass Filter	3.0	Automatic IF selection; input high-pass filter out												
		<table border="1"> <thead> <tr> <th>IF (MHz)</th> <th>Input High-Pass Filter</th> </tr> </thead> <tbody> <tr> <td>0.455</td> <td>Out</td> </tr> <tr> <td>1.5</td> <td>Out</td> </tr> <tr> <td>0.455</td> <td>In</td> </tr> <tr> <td>1.5</td> <td>In</td> </tr> </tbody> </table>	IF (MHz)	Input High-Pass Filter	0.455	Out	1.5	Out	0.455	In	1.5	In		
	IF (MHz)	Input High-Pass Filter												
	0.455	Out												
	1.5	Out												
0.455	In													
1.5	In													
3.1	0.455	Out												
3.2	1.5	Out												
3.3	0.455	In												
3.4	1.5	In												
Tune Mode	4.0	Automatic tuning; low noise LO												
	4.1	Automatic tuning; track mode												
	4.2	Manual tuning via keyboard entry												
Audio Peak Detector Time Constant	5.0	Fast peak detector												
	5.1	Slow peak detector												
AM ALC Response	6.0	Slow AM ALC response												
	6.1	Fast AM ALC response												
	6.2	AM ALC off												
Frequency Resolution	7.0	Automatic selection												
	7.1	10 Hz resolution (f<1 GHz)												
	7.2	1000 Hz resolution												
Error Disable	8.0	Automatic selection												
	8.1	E01 disabled												
	8.2	E02 and E03 disabled												
	8.3	E01, E02, & E03 disabled												
	8.4	E04 disabled												
	8.5	E01 and E04 disabled												
	8.6	E02, E03, & E04 disabled												
	8.7	E01 through E04 disabled												
	8.8	E01 through E04 enabled												

Then, whenever the FM deviation exceeds 75 kHz the limit light turns on. The limit function is most useful when used along with the 22. special function which generates a service request when the limit is reached. These two special functions enable the analyzer to become a remote modulation monitor. The most commonly used special functions are described in Table 6-3 and on the 8901A pullout information card. The green automatic operation key clears special functions with prefix numbers 1 through 8, 9, 15, and 21.

# 5. Calibrator Operation and Theory

## Introduction

One of the unique features and contributions of the 8901A is the AM and FM calibrator option. The task of verifying and calibrating the Modulation Analyzer is formidable since the basic accuracy specification is  $\pm 1\%$  of reading. Precise AM signals are difficult to generate and the Bessel null technique which is often used to generate known FM deviations accurately is time consuming, requires extra test equipment (signal generator, audio source, frequency counter, and spectrum analyzer) and provides insufficient accuracy ( $\approx 1\%$ ), for calibrating the 8901A. These difficulties are overcome by the internal calibrators. They provide a 10 MHz, 10 kHz rate signal with either a nominal AM depth of 33.3% or 33 kHz peak FM deviation. The calibration output signal is generated by switching between two RF levels for AM or between two frequencies for FM. These two levels (or frequencies) are measured statically with high accuracy using the internal voltmeter (or counter). The calibrator modulation is then calculated from these measurements. The exact % AM (or peak FM deviation) generated can be displayed using the 12.0 (13.0) special function. The indicated modulation is accurate to  $\pm 0.1\%$  of reading. Thus, high accuracy is achieved by statically measuring the two levels (or frequencies) of the calibration output which is generated by dynamically switching between the same levels (frequencies).

With the calibrator signal connected to the 8901A RF input the accuracy of the Modulation Analyzer is measured directly and displayed in %. For example, 100.12% means the 8901A is reading 0.12% high. At recommended calibration cycles (1 year) the 8901A is adjusted to read 100%. The calibration factor can be incorporated in subsequent modulation measurements using special functions to achieve typical accuracy of  $\pm 0.6\%$  of reading. The calibrator output may also be used to calibrate other Modulation Analyzers not fitted with the calibrator option. Thus, users buying several 8901A's need not include the calibrators in every unit to keep them maintained.

## AM Calibrator

### Generating the AM Calibrator Signal

The 10 MHz signal is applied to two identical modulators (A and B) which are isolated by buffer amplifiers (Figure 5-1). When the CALIBRATION key is pressed the Modulation Analyzer statically measures the

two carrier levels,  $V_A$  and  $V_B$  (Figure 5-2). The output signal used to calibrate the modulation analyzer is dynamically generated by closing modulator A and switching modulator B on and off with the shaped square wave drive signal (Figure 5-2b). The A and B signals are summed producing the composite waveform in Figure 5-2c and 5-3. The shaping prevents the demodulation circuitry from ringing when the CALIBRATION OUTPUT is measured.

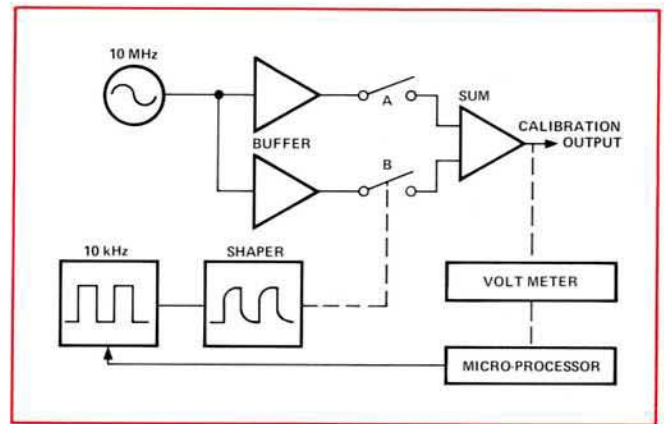

Figure 5-1. AM calibrator block diagram.

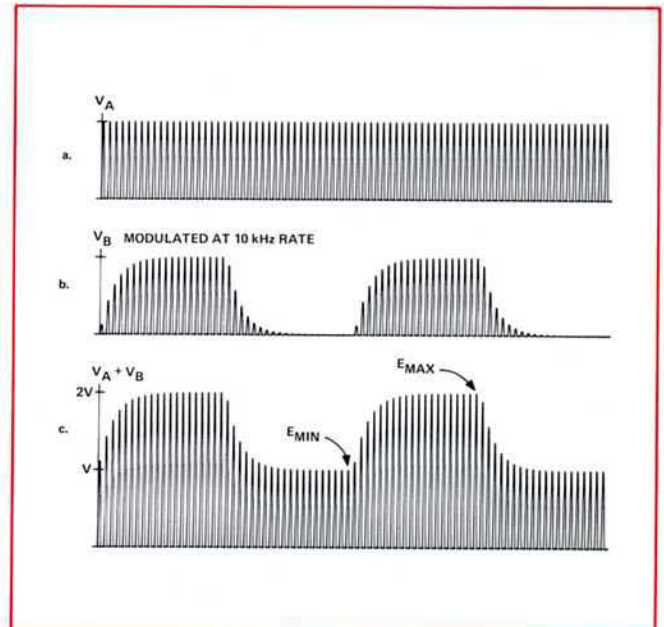

Figure 5-2. Forming the AM calibrator signal.



## Calculating AM Calibrator Depth

AM depth is defined by<sup>1</sup>:

$$m_+ = \frac{E_{\max} - E_{\text{avg}}}{E_{\text{avg}}} \times 100, m_- = \frac{E_{\text{avg}} - E_{\min}}{E_{\text{avg}}} \times 100 \quad (5-1)$$

where  $m_+$  and  $m_-$  are the positive and negative peak modulation depths and  $E_{\max}$ ,  $E_{\min}$ , and  $E_{\text{avg}}$  are the maximum, minimum, and average carrier levels as shown in Figure 5-4. The 8901A and most other modulation meters measure AM depth using equations 5-1.

The average modulation  $m$  is given by:

$$m = \frac{m_+ + m_-}{2} \quad (5-2)$$

If the modulation waveform is symmetrical as in Fig. 5-3 or 5-4, then

$$E_{\text{avg}} = \frac{E_{\max} + E_{\min}}{2} \quad (5-3)$$

Substituting Eqs. 5-1 and 5-3 into 5-2 yields:

$$m = \frac{E_{\max} - E_{\min}}{E_{\max} + E_{\min}} \times 100 \quad (5-4)$$

Equation 5-4 is an alternate definition of AM that is often used, particularly when AM is measured with oscilloscopes. Equation 5-4 is used to calculate the calibrator AM depth since  $E_{\min}$  and  $E_{\max}$  are determined to high accuracy statically.  $E_{\min}$  is measured with modulator A closed and modulator B open. This is  $V_A$  shown in Figure 5-2a. Next,  $V_B$  is measured with modulator A open and modulator B closed.  $E_{\max}$  is obtained by adding  $V_A$  and  $V_B$ .

$$E_{\max} = V_A + V_B \quad (5-5)$$

Because  $V_A$  is very nearly equal to  $V_B$ , the RF detector and voltmeter are operated over a very narrow range when  $V_A$  and  $V_B$  are measured separately. The result is excellent linearity. This linearity would not be possible if  $E_{\max}$  were measured directly. However, this does require that the relative phase shift between the A path (consisting of modulator A and buffer A) and the B path (consisting of modulator B and buffer B) be minimal for Eq. 5-5 to be valid. Typically, the relative phase shift is less than two degrees. The actual phase shift can be verified easily using an HP 8405A Vector Voltmeter. For phase shifts this small, the error introduced in Eq. 5-5 is negligible. Substituting  $V_A$  for  $E_{\min}$  and  $V_A + V_B$  for  $E_{\max}$  in Eq. 5-4 yields:

$$m = \frac{V_B}{2 V_A + V_B} \times 100 \quad (5-6)$$

This result can be displayed with the 13.0 special function. Notice that if  $V_A = V_B$  then  $m = 33.33$  from Eq. 5-6. However, this technique does not require that  $V_A$  equal  $V_B$  since both levels are measured. Thus, the calculated modulation may differ from 33.33 by several percent but the accuracy remains  $\pm 0.1\%$  of reading.

## Comparing Measured with Calculated AM Depth

When the CALIBRATION OUTPUT is connected to the RF input, the 8901A measures the positive ( $m_+$ ) and negative ( $m_-$ ) AM depth. This intermediate result can be displayed using the 13.2 special function and selecting either PEAK + or PEAK -. If the 10 kHz signal driving modulator B is perfectly symmetrical, then  $m_+ = m_- = m$ . The 8901A does not depend on this, however, since drift may cause a small amount of asymmetry to occur. Asymmetry causes the average carrier level  $E_{\text{avg}}$  to shift, and changes both  $m_+$  and  $m_-$ . Since the calculated modulation,  $m$ , is a function of  $E_{\max}$  and  $E_{\min}$  only, it is unaffected by asymmetry. The error due to asymmetry

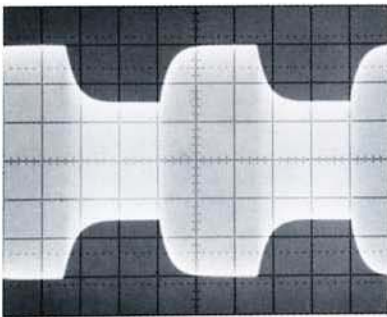

Figure 5-3. AM calibrator waveform.

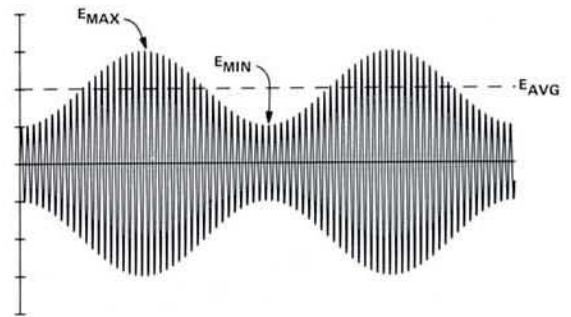

Figure 5-4. RF carrier modulated with 50% AM.

<sup>1</sup>Frederick E. Terman, Electronic and Radio Engineering, McGraw Hill Book Co., fourth edition, page 523.

when comparing the measured AM depth  $m_+$  and  $m_-$  to the calculated depth  $m$  is eliminated using the relation:

$$m = \frac{m_+ + 2m_-}{3} \quad (5-7)$$

The negative peak,  $m_-$ , is given twice the weighting of  $m_+$  in Eq. 5-7 because the corrective action of the automatic gain control (AGC) in the AM detector in response to a shift in average carrier level changes the minimum level (and  $m_-$ ) only half as much as the maximum level (and  $m_+$ ). The measured AM depth,  $m$ , is automatically determined from Eq. 5-7 when the 8901A performs self-calibration. When one 8901A is calibrated with another,  $m$  is calculated manually as outlined in the calibration procedure in this section.

The only significant difference between the calculated AM depth from Eq. 5-6 and the measured value from Eq. 5-7 other than the error due to being out of calibration is due to the effect of residual noise. To correct for this noise, the 8901A measures the peak residual AM of the calibrator's unmodulated output and corrects the result with the appropriate weighting factor. The weighted residual AM can be displayed using the 13.1 special function. (Section 4 describes accounting for peak residuals further.) The AM cal factor displayed is the average measured AM depth corrected for noise effects divided by the calculated calibrator AM depth expressed in percent.

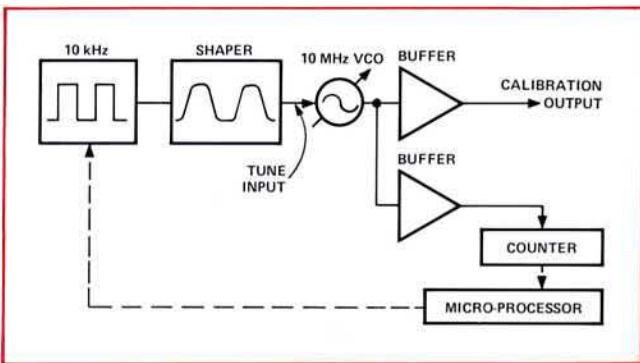

Figure 5-5. FM calibrator block diagram.

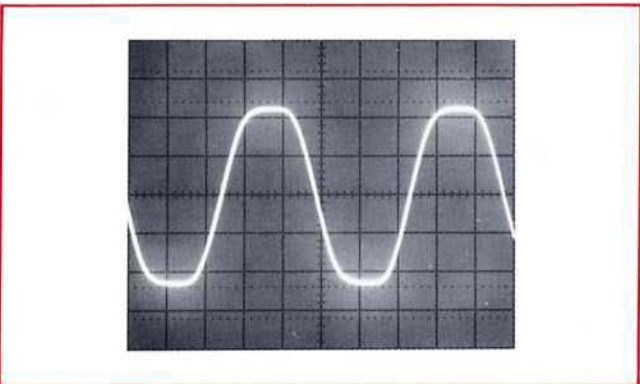

Figure 5-6. FM calibrator modulation waveform.

## FM Calibrator

### Generating the FM Calibrator Signal and Calculating Deviation

The FM calibrator is very analogous to the AM calibrator. The same 10 MHz source is switched between two discrete frequencies by a shaped square-wave to provide approximately 33 kHz of peak FM deviation (Figure 5-5). When the calibrator button is pressed, the VCO input is driven to the high frequency peak  $f_h$ , and the frequency is measured by the internal counter. Then the VCO is driven to the low frequency peak  $f_l$  and the frequency is counted again. The average peak deviation  $\Delta f_{\text{peak avg}}$  is calculated by:

$$\Delta f_{\text{peak avg}} = \frac{f_h - f_l}{2} \quad (5-8)$$

This value can be displayed using the 12.0 special function. The calibrator signal used to verify the 8901A accuracy is switched at a 10 kHz rate (Figure 5-6). The shaping prevents the demodulation circuitry from ringing when the CALIBRATION OUTPUT is measured.

### Comparing Measured with Calculated FM Deviation

The 8901A measures peak deviation as the difference between the peak and the average carrier frequency. The equations for positive and negative peak deviation are

$$\Delta f_{p+} = f_h - f_{\text{avg}} \quad (5-9)$$

$$\Delta f_{p-} = f_{\text{avg}} - f_l$$

When the calibration output is connected to the RF input, the 8901A automatically measures  $\Delta f_{p+}$  and  $\Delta f_{p-}$ . These measurements can also be displayed using the 12.2 special function and selecting either PEAK+ or PEAK-. Next, the 8901A determines average measured peak deviation using

$$\Delta f_{\text{peak avg}} = \frac{\Delta f_{p+} + \Delta f_{p-}}{2} = \frac{(f_h - f_{\text{avg}} + f_{\text{avg}} - f_l)}{2} \quad (5-10)$$

Eq. 5-10 shows that any shifts in the average frequency,  $f_{\text{avg}}$ , due to asymmetry in the modulation waveform are eliminated by calibrating using the average peak deviation. The average peak deviation is computed automatically except when one Modulation Analyzer is used to verify the accuracy of another. In this case,  $\Delta f_{\text{peak avg}}$  is calculated manually as indicated in the calibration procedure in this section.

The only significant difference between the calculated peak deviation and the average measured peak deviation just described other than the error due to being out of calibration, is due to the effect of residual noise. To correct for this noise the 8901A measures the peak residual deviation of the calibrator's unmodulated output

and corrects the result with the appropriate weighting factor. The weighted residual deviation can be displayed with special function 12.1. The FM calibration factor displayed is the average measured peak deviation corrected for noise effects divided by the true calculated peak deviation. This is all performed automatically if the 8901A has the calibrator option installed.

## Verifying Accuracy

Verifying the accuracy of the 8901A is a simple two step procedure:

1. Connect the CALIBRATION OUTPUT to the RF input.
2. To automatically perform AM or FM accuracy verification, press



or



When the CALIBRATION button is pressed the 8901A calculates the calibrator modulation. Next, the analyzer turns off all high-pass, low-pass, and de-emphasis filters. Then it tunes to the calibrator signal and measures the modulation. After approximately 22 seconds the 8901A displays a number close to 100%. Most of this time is spent averaging readings to reduce noise effects. The number is the calibration factor which represents the measured modulation expressed as a percentage of the calibrator modulation. For example, if after performing the calibration procedure the display indicates 100.12%, this means that the 8901A reads 0.12% high. Since specified accuracy is  $\pm 1\%$  of reading, the calibration factor displayed should always be within 99.0% and 101.0% between calibration cycles.

## Calibrator Special Functions

Some of the intermediate results performed during calibration are available as special functions. Table 5-1 summarizes the special functions related to the calibrators. The AM (FM) calibration factor displayed is related to the 13. (12.) special functions by:

$$\text{AM Cal Factor} = \frac{(13.2 \text{ reading} - 13.1 \text{ reading})}{(13.0 \text{ reading})} \times 100\% \quad (5-11)$$

$$\text{FM Cal Factor} = \frac{(12.2 \text{ reading} - 12.1 \text{ reading})}{(12.0 \text{ reading})} \times 100\% \quad (5-12)$$

## Verifying the Accuracy of a Second 8901A

Using the calibrator special functions described above, one 8901A equipped with calibrators (Option 010) may be used to verify the accuracy of a second 8901A.

The AM calibration procedure is:

1. Connect the CALIBRATION OUTPUT of Modulation Analyzer A to the RF input of Modulation Analyzer B (Figure 5-7).

2. Key in



to Modulation Analyzer A and note the reading. This is the calibrator AM depth.

3. Key in



to both instruments and note the displayed reading of analyzer B. This is the peak residual AM of the calibrator's unmodulated output measured with analyzer B. (If display jitter makes it difficult to read the display, key in 5.1 SPCL).

4. Key in



to both instruments noting the reading on the display of analyzer B. This is the peak AM depth of the calibrator measured with Modulation Analyzer B.

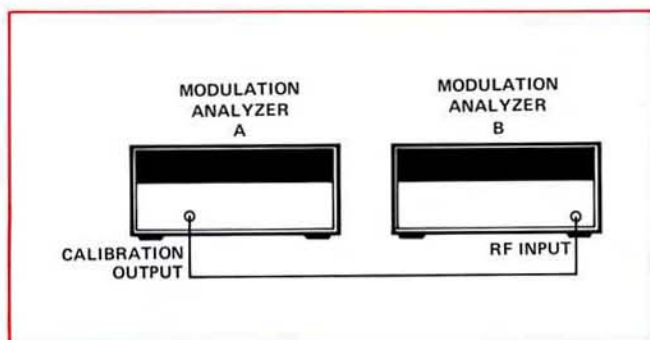

Figure 5-7. Verifying the accuracy of a second 8901A.

5. On Modulation Analyzer B, press PEAK-. Note the reading on the display of Modulation Analyzer B. If the difference between the readings of steps 4 and 5 is <3 in the least significant digit, use the reading from step 3. If the difference between the two readings is >3 in the least significant digit, compute the average as follows:

$$\text{13.2 reading} = \frac{(\text{reading of step 4}) + 2 \times (\text{reading of step 5})}{3} \quad (5-13)$$

For FM, if the difference is > 3 counts, compute the average as:

$$\text{12.2 reading} = \frac{(\text{reading of step 4}) + (\text{reading of step 5})}{2} \quad (5-14)$$

6. Compute the AM Cal Factor of Modulation Analyzer B using the AM Cal formula:

$$\text{AM Cal Factor} = \frac{(\text{13.2 reading} - \text{13.1 reading})}{\text{13.0 reading}} \times 100 \quad (5-15)$$

The procedure for FM is identical except the 12. special function prefix is used whenever the 13. is used above.

## Improving Accuracy Using the Calibration Factor

Special functions allow the calibration factors to be incorporated in modulation measurements for improved accuracy. The 8901A modulation accuracy is  $\pm 1\%$  of reading for most rates, depths, and deviations even though the calibrator is accurate to 0.1% of reading. This is because the calibrator verifies accuracy at a single rate and for one AM depth or FM deviation. The  $\pm 1\%$  of reading specification includes the effects of flatness and linearity with rate and modulation and also environmental effects. The environmental effects are mostly temperature related and can be removed by verifying the accuracy at the operating temperature and using the calibration factors in subsequent measurements. Keying in special functions 16.1 and 17.1 causes all subsequent readings to be corrected using the AM or FM calibration factors (Table 5-1). For example, if the AM calibration factor is 100.12 all readings are scaled by 100/100.12 before displaying the result. With the calibration factors enabled typical accuracy is  $\pm 0.6\%$  of reading  $\pm 1$  digit.

**Table 5-1.** Calibration special functions.

Function	Special Function Code	
	AM	FM
Display computed peak modulation (calibrator)	13.0 SPCL	12.0 SPCL
Display weighted demodulated peak residual modulation	13.1 SPCL	12.1 SPCL
Display demodulated peak modulation	13.2 SPCL	12.2 SPCL
Disable Cal Factor	16.0 SPCL	17.0 SPCL
Enable Cal Factor	16.1 SPCL	17.1 SPCL
Read Cal Factor	16.2 SPCL	17.2 SPCL

# 6. Remote Operation

The 8901A Modulation Analyzer is fully programmable. All front panel functions, except the line switch, can be controlled using HP-IB. In addition, all special functions are programmable yielding increased measurement flexibility and serviceability. This section is an overview of programming the 8901A. In addition to addressing, program codes, and data message formats, specific examples are given using various HP instrument controllers including 9825A, 9835A, 9845B/T, and HP 1000 computers. Instrument subroutines are given and an example program to test FM mobile transmitters using a 9825 Desktop Computer is included.

## Displaying and Setting the Address

The 8901A listen and talk addresses are preset to the ASCII symbols "." and "N". This corresponds to a decimal equivalent of 14. The 5 bit binary representation of the address is displayed on the front panel by keying in 21.SPCL (Figure 6-1). If the HP-IB interface board is not installed or all seven switches are set to 1, the display reads out 11111.110 and HP-IB operation is disabled.

The address is easily modified by sliding the top cover back and adjusting the binary switches (Figure 6-2). The display is updated immediately for any change in the address switches. The TALK ONLY (TON) and LISTEN ONLY (LON) bits should both be set to zero for normal (addressable) HP-IB operation. Table 6-1 lists the allowable address codes.

Table 6-1. Allowable address codes.

Address Switches					Talk Address Character	Listen Address Character	Decimal Equivalent
A <sub>3</sub>	A <sub>4</sub>	A <sub>1</sub>	A <sub>2</sub>	A <sub>1</sub>			
0	0	0	0	0	@	SP	0
0	0	0	0	1	A	!	1
0	0	0	1	0	B	"	2
0	0	0	1	1	C	#	3
0	0	1	0	0	D	\$	4
0	0	1	0	1	E	%	5
0	0	1	1	0	F	&	6
0	0	1	1	1	G	'	7
0	1	0	0	0	H	(	8
0	1	0	0	1	I	)	9
0	1	0	1	0	J	*	10
0	1	0	1	1	K	+	11
0	1	1	0	0	L	.	12
0	1	1	0	1	M	-	13
0	1	1	1	0	N	:	14*
0	1	1	1	1	O	/	15
1	0	0	0	0	P	0	16
1	0	0	0	1	Q	1	17
1	0	0	1	0	R	2	18
1	0	0	1	1	S	3	19
1	0	1	0	0	T	4	20
1	0	1	0	1	U	5	21**
1	0	1	1	0	V	6	22
1	0	1	1	1	W	7	23
1	1	0	0	0	X	8	24
1	1	0	0	1	Y	9	25
1	1	0	1	0	Z	:	26
1	1	0	1	1	[	:	27
1	1	1	0	0	\	<	28
1	1	1	0	1	]	=	29
1	1	1	1	0	-	>	30

\* 14 is factory preset address  
 \*\* 21 is the 98034A HP-IB interface preset address.  
 Therefore, the 8901A should not be set to 21.

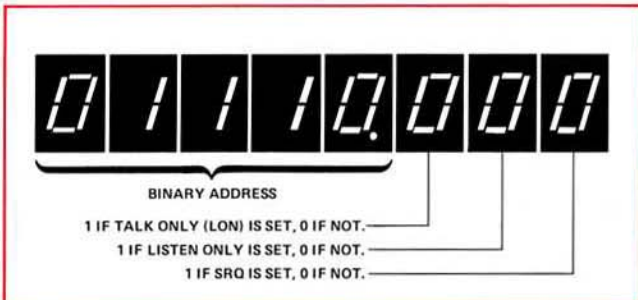

Figure 6-1. Remote address display.

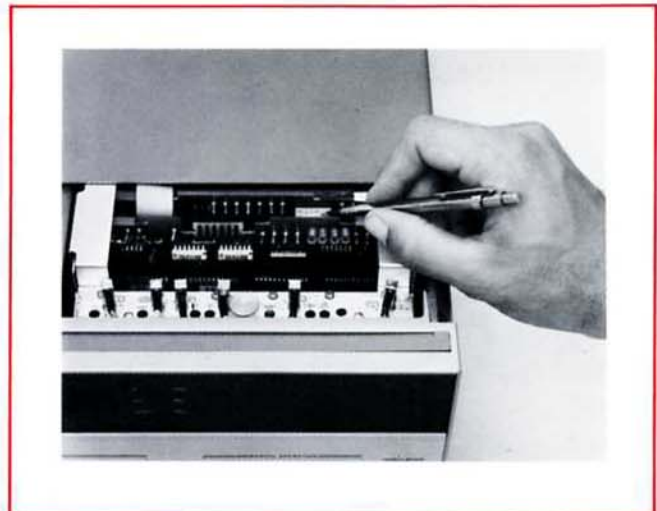

Figure 6-2. 8901A address setting.

## Program Codes

The program code set for the 8901A is given in Table 6-2. The programming format consists of a program code prefix and a single digit argument. The prefix codes are single alphanumeric characters which are underlined in light grey on the front panel for quick reference.

The program codes for automatic and manual operation are two alphanumeric characters. The increment, decrement, and manual frequency input functions are suffix codes. A numerical argument must precede the suffix code. For example, the command string to set the 8901A input frequency to 454.5 MHz is "454.5MZ". Special functions can be programmed using the codes from Table 6-3 and the suffix "SP". For example, the command string for 10 Hz counter resolution is "7.1SP".

## Code Simplifications and Conventions

The 8901A ignores: spaces ! " # \$ % & ( ) \* / ' (commas), carriage returns (CR), and line feeds (LF). As a convenience, all lower case alpha characters are treated as upper case, and the letter "O" is treated the same as zero. The Modulation Analyzer always outputs and displays E24 (bus code error) if it receives: @ B G I J N Q V W Y [ / ]  $\sim$   $\wedge$   $\left\{ \begin{array}{l} | \\ | \end{array} \right\} \sim$  or DEL.

Table 6-2. 8901A program code set.

	Program Code
<b>Measurement</b>	
AM	M1
FM	M2
$\Phi$ M	M3
RF Level	M4
Frequency	M5
IF Level	S3
Tuned RF Level	S4
Frequency Error	S5
<b>High-Pass Filters</b>	
Off	H0
50 Hz	H1
300 Hz	H2
<b>Low-Pass Filters</b>	
Off	L0
3 kHz	L1
15 kHz	L2
>20 kHz	L3
<b>FM De-emphasis</b>	
De-emphasis and Pre-display Off	P0
Pre-display On	P1
25 $\mu$ s	P2
50 $\mu$ s	P3
75 $\mu$ s	P4
750 $\mu$ s	P5
<b>Detector</b>	
Peak +	D1
Peak -	D2
Peak Hold	D3
Average	D4
<b>Ratio</b>	
Off	R0
%	R1
dB	R2
<b>Trigger</b>	
Free Run	T0
Hold	T1
Immediate	T2
Trigger with Settling	T3
<b>Automatic Operation</b>	AU
<b>Manual Operation</b>	
MHz Input Frequency	MZ
Hz Input Frequency	HZ
Increment (1kHz)	KU
(1 Hz)	HU
Decrement (1kHz)	KD
(1 Hz)	HD
SPCL	SP
SPCL SPCL	SS
Clear	CL
<b>Calibrator</b>	
Off	C0
On	C1

**Table 6-3.** 8901A special function code set.

Function	Code	Description												
Input Attenuation	1.0	Automatic selection												
	1.1	0 dB input attenuation												
	1.2	10 dB input attenuation												
	1.3	20 dB input attenuation												
	1.4	30 dB input attenuation												
	1.5	40 dB input attenuation												
	1.6	50 dB input attenuation												
Modulation Range	2.0	Automatic selection <table border="1" style="margin-left: 20px;"> <thead> <tr> <th>AM (%)</th> <th>FM (kHz)</th> <th>ΦM (rad)</th> </tr> </thead> <tbody> <tr> <td>≤ 40</td> <td>≤ 4</td> <td>≤ 0.4*</td> </tr> <tr> <td>≤ 100</td> <td>≤ 40</td> <td>≤ 4*</td> </tr> <tr> <td>≤ 100</td> <td>≤ 400</td> <td>≤ 40*</td> </tr> </tbody> </table> *with 750μs de-emphasis pre-display	AM (%)	FM (kHz)	ΦM (rad)	≤ 40	≤ 4	≤ 0.4*	≤ 100	≤ 40	≤ 4*	≤ 100	≤ 400	≤ 40*
	AM (%)	FM (kHz)	ΦM (rad)											
	≤ 40	≤ 4	≤ 0.4*											
	≤ 100	≤ 40	≤ 4*											
	≤ 100	≤ 400	≤ 40*											
2.1														
2.2														
2.3														
IF Frequency and Input High-Pass Filter	3.0	Automatic IF selection; input high-pass filter out <table border="1" style="margin-left: 20px;"> <thead> <tr> <th>IF (MHz)</th> <th>Input High-Pass Filter</th> </tr> </thead> <tbody> <tr> <td>0.455</td> <td>Out</td> </tr> <tr> <td>1.5</td> <td>Out</td> </tr> <tr> <td>0.455</td> <td>In</td> </tr> <tr> <td>1.5</td> <td>In</td> </tr> </tbody> </table>	IF (MHz)	Input High-Pass Filter	0.455	Out	1.5	Out	0.455	In	1.5	In		
	IF (MHz)	Input High-Pass Filter												
	0.455	Out												
	1.5	Out												
	0.455	In												
	1.5	In												
3.1														
3.2														
3.3														
3.4														
Tune Mode	4.0	Automatic tuning; low noise LO												
	4.1	Automatic tuning; track mode												
	4.2	Manual tuning via keyboard entry												
Audio Peak Detector Time Constant	5.0	Fast peak detector												
	5.1	Slow peak detector												
AM ALC Response	6.0	Slow AM ALC response												
	6.1	Fast AM ALC response												
	6.2	AM ALC off												
Frequency Resolution	7.0	Automatic selection												
	7.1	10 Hz resolution (f<1GHz)												
	7.2	1000 Hz resolution												
Error Disable	8.0	Automatic selection												
	8.1	E01 disabled												
	8.2	E02 and E03 disabled												
	8.3	E01, E02, & E03 disabled												
	8.4	E04 disabled												
	8.5	E01 and E04 disabled												
	8.6	E02, E03, & E04 disabled												
	8.7	E01 through E04 disabled												
	8.8	E01 through E04 enabled												
Hold Settings	9.0	Holds ranges, tuning and error modes at present settings; disables automatic functions												
IF Frequency Measurement	10.0	Measures IF signal frequency												
Re-enter RATIO with Previous Reference	11.0	Re-enter % RATIO												
	11.1	Re-enter dB RATIO												
	11.2	Read RATIO reference												
	11.3	Make RATIO reference negative												

Function	Code	Description
FM Calibrator (Option 010)	12.0	Display computed peak FM deviation
	12.1	Display demodulated peak residual FM deviation
	12.2	Display demodulated peak FM deviation
AM Calibrator (Option 010)	13.0	Display computed peak AM depth
	13.1	Display demodulated peak residual AM depth
	13.2	Display demodulated peak AM depth
Set Limit	14.0	Clear Limits; turn off LIMIT annunciator
	14.1	Set lower limit to RATIO reference
	14.2	Set upper limit to RATIO reference
	14.3	Restore lower limit
	14.4	Restore upper limit
	14.5	Read lower limit
	14.6	Read upper limit
	14.7	Read lower limit measurement code
14.8	Read upper limit measurement code	
Time Base Oven (Option 002)	15.0	Display E12 if internal reference oven is cold
AM Calibration (Option 010)	16.0	Disable AM calibration factor
	16.1	Enable AM calibration factor
	16.2	Read AM calibration factor (0 if not enabled)
FM Calibration (Option 010)	17.0	Disable FM calibration factor
	17.1	Enable FM calibration factor
	17.2	Read FM calibration factor (0 if not enabled)
Tone Burst Receiver	18.NN	Configures the Modulation Analyzer as a tone burst receiver where a settling time is inserted between detecting a carrier and turning on MODULATION OUTPUT. NN is that time from 1 through 99 ms. If NN = 0, the delay is 99 ms.
HP-IB Address	21.0	Displays HP-IB address in form AAAAA.TLS. AAAAA is the binary address. T = 1 means talk only. L = 1 means listen only; S = 1 means service request issued.
Service Request	22.NN	Enables a condition to cause a service request to be issued. NN is the sum of any combination of the weighted conditions below: 1 Data ready 2 HP-IB error 4 Instrument error 8 Upper limit reached 16 Lower limit reached Instrument powers up in the 22.2 state.

## Programming Order Considerations

Order is important when programming the 8901A. The code "AU" places the 8901A in automatic operation and clears all special functions with prefix numbers 1 through 8, 9, 15, and 21. Therefore, any desired special functions should be after "AU" in the program code sequence.

Because measurement cycles are always executed immediately after a trigger command is received, trigger commands should always be last in a programming sequence. The code "P0" not only turns off pre-display mode but also all de-emphasis. Consequently, de-emphasis filter codes should be after pre-display on "P1" or off "P0". Peak hold mode works with either the positive or negative peak detector. Pressing either PEAK + or PEAK - or changing measurement modes (e.g., AM to FM) in local operation takes the 8901A out of peak hold mode. Pressing PEAK HOLD after PEAK + or PEAK - turns on peak hold mode. Remote operation is the same as local operation. Therefore, peak hold mode "D3" must be programmed after selecting PEAK + or PEAK -. The following rules should always be followed:

1. Any desired special functions should be **after** "AU".
2. De-emphasis filters code should be **after** selecting pre-display on or off.
3. PEAK HOLD should be **after** selecting PEAK + or PEAK - and **after** changing measurement modes.
4. Trigger commands should be last.

An easy way to remember rules 2 and 3 is that the arguments must be in ascending order. For example, the program sequence to set positive peak hold is "D1D3". The following examples clarify the use of these rules.

**Example:** A typical code sequence to set up the modulation analyzer for an instantaneous FM modulation limiting measurement is:

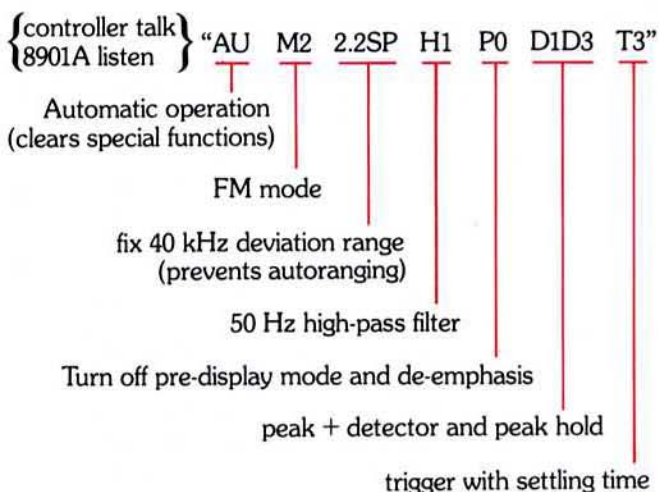

**Example:** Select the 750  $\mu$ s de-emphasis filter and PRE-DISPLAY on:

{ controller talk } "P1P5"  
{ 8901A listen }

**Example:** Select the 75  $\mu$ s de-emphasis filter and PRE-DISPLAY off:

{ controller talk } "P0P4"  
{ 8901A listen }

**Example:** Select the PEAK - detector and turn off PEAK HOLD mode:

{ controller talk } "D2"  
{ 8901A listen }

## Triggered Operation

The 8901A has a full complement of triggered modes of operation (Table 6-4). The 8901A executes measurement cycles continuously in free run mode (T0) as it does in local. In hold mode (T1) the 8901A does not output to the display or to the bus. The trigger immediate command (T2) causes the 8901A to make one measurement cycle and wait to be read. Trigger with settling time (T3) causes the 8901A to execute one measurement cycle after delaying to allow internal circuits to settle. In both trigger immediate and trigger with settling modes the analyzer enters hold mode after the reading is output to the controller.

Trigger with settling (T3) is recommended for most applications. It provides a valid reading in the shortest time and eliminates the need to perform software checks for proper settling. The subroutines and examples in this section all use trigger with settling. Another advantage of trigger with settling mode is in debugging programs. The 8901A display holds the reading after it is output to the controller. Thus it is easy to check that program variables are assigned proper values as the program is stepped through. The CLEAR key is another debugging aid. Whenever CLEAR is pressed during remote operation, the 8901A executes a measurement cycle. This is useful for identifying timing problems in systems. For example, when the 8901A is triggered under program control, the input signal might not be settled or present due to system switching transients. Pressing CLEAR after a few seconds and noting the change in the new reading is a quick way to check for timing problems.

**Table 6-4.** 8901A trigger modes.

Trigger Mode	HP-IB Code
Free Run	T0
Hold	T1
Immediate	T2
Trigger with Settling	T3



## Output Data Message Format

The Modulation Analyzer outputs readings in a 15 byte format (Figure 6-3). The output message is in exponential form. It begins with a + or - sign and ends with a carriage return (CR) and line feed (LF). Data is always output in fundamental units: Hz, watts, radians, % or dB. Error messages indicated on the display can also be read remotely. The error output format is +900000NNE+02CRLF where NN is the error number. When an error occurs, the instrument error (NN) is obtained by addressing the 8901A to talk, subtracting  $9 \times 10^9$  from the reading returned, and dividing by 100. The operating information pull-out card lists all the error codes.

**Example:** Display reads: 969.21346 MHz  
Data output: +96921346E+01CRLF

**Example:** Display reads: 34.92 kHz  
Data output: +00003492E+01CRLF

**Example:** In the 9825A example program Figure 6-4, execution branches to the error trapping subroutine "trap" if an error occurs. The "trap" subroutine determines the error number and prints a diagnostic message if either E96 or E06 occurs. When no input signal is sensed by the 8901A, the display indicates two dashes and E96 is output to the bus. E06 occurs if the input power protect relay is tripped by an input overload.

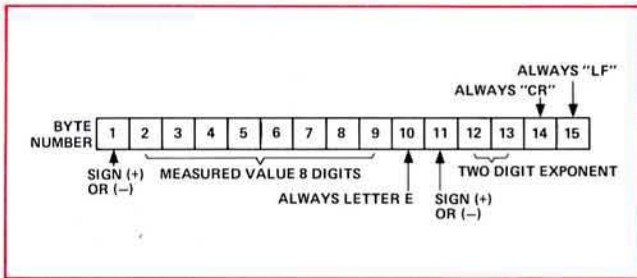

Figure 6-3. 8901A output message format.

## Service Request and Status Reporting

The 8901A can request service via the interface SRQ for five conditions. These conditions are

1. Data ready
2. Invalid programming code error
3. Instrument error
4. Upper limit reached
5. Lower limit reached

When addressed to talk during a serial poll, the 8901A sends the status byte as shown in Figure 6-5. The operator has control over which conditions cause the 8901A to request service using special function 22.X. To enable an SRQ-generating condition, use the 22.X special function with argument X equal to the sum of the bit values for the desired service request condition. The bits in the status byte can be set to one only if they are enabled. The invalid programming code is an exception. An invalid program code always generates a service request even if an attempt is made to mask it off. The 8901A powers up in the 22.2 state. Bit 6 (SRQ) is set true whenever any of the other status bits are set. All bits remain set until the status byte is read. Bits 5 and 7 are always 0.

Bit	Bit Value	Function
0	1	Data Ready
1	2	Bus Code Error
2	4	Instrument Error
3	8	Upper Limit Reached
4	16	Lower Limit Reached
5	32	0
6	64	Service Request
7	128	0

Figure 6-5. 8901A status byte

```

0: "Error trapping example":
1:
2: rem 7 _____ Set remote enable
3: wtb 714, "M1T0" _____ Trigger an AM measurement
4: "error could occur": _____ The 8901A will display E06 if an overload occurs.
5: fmt ;red 714, A _____ Read 8901A
6: if A>9e9; cll 'trap'; gto "Continue" _____ Branch to "trap" if an error has occurred
7: prt "AM depth= ", A, "%" _____ If no error, print measurement result
8: "Continue":
9: stp _____ Stop
10:
11: "trap": _____ Subroutine to determine error number
12: (A-9e9)/100>E _____ Determine error code (E)
13: if E=96; prt "No input signal"; ret _____ Print error message if E96 occurs
14: if E=6; prt "Input power", "protect relay", "open" _____ Print error message if E06 occurs
15: ret _____ Return
    
```

Figure 6-4. 8901A error trapping example.

**Example:** Enable the 8901A to generate a service request when data is ready or lower limit is reached. The argument is  $16 + 1 = 17$ , and the special function is 22.17. This could be programmed using the general form:

```
{ controller talk } "22.17SP"
  { 8901A listen }
```

or specifically with the 9825A: wtb 714, "22.17SP",  
or the 9835A or 9845B/T:

```
OUTPUT 714 USING "K"; "22.17SP"
```

**Example:** Using the equipment shown (Figure 6-6), the example subprogram "limit" (Figure 6-7) interrupts the main program and prints the FM deviation with the 9825A strip printer whenever the source peak FM deviation is less than 60 kHz or greater than 70 kHz.

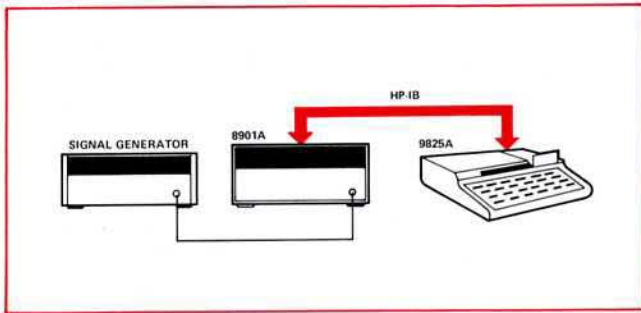

Figure 6-6. Example service request setup.

## Programming Execution Time

The reading rate in remote operation is determined by two parameters: the rate at which data can be input to the 8901A via the HP-IB interface, and the time required for the 8901A to execute a measurement cycle and output the measurement result. Because the 8901A accepts data at a 273 bytes/second rate, data transfer is normally a small fraction of the total program run-time. Execution time is almost completely a function of internal hardware settling times. Table 6-5 lists typical execution times for various measurement functions and trigger modes. RF level is the fastest mode for the 8901A to return the first reading. This is because RF level is a broadband measurement and does not require the 8901A to tune. The remaining functions (AM, FM,  $\Phi$ M, and frequency) all require the 8901A to tune to the input signal before measurements can be made. The times to return the first reading given in Table 6-5 vary with input frequency, modulation rate, and modulation deviation or depth. These times assume that the 8901A is not already tuned. Once tuned, the time to switch between any of the tuned functions is typically less than one second. When several measurement modes are used in succession, Table 6-5 suggests that the optimum sequence is RF level, frequency, AM, FM, and  $\Phi$ M. Using the audio measurement bandwidth filters also results in faster readings. Particularly helpful is the 50 Hz high-pass filter in AM and FM modes and the 15 kHz low-pass filter in FM Mode for deviations less than 4 kHz.

```
0: "Service request example":
1: rem 7 _____ Set remote enable true
2: oni 7, "limit" _____ Branch to "limit" when an interrupt occurs
3: wtb 714, "M2T070R114.2SP" _____ Put 8901A in FM mode, set lower limit to 60 kHz deviation
4: wtb 714, "60R114.1SPR0" _____ Set upper limit to 70 kHz, turn off ratio mode
5: wtb 714, "22.24SP" _____ Set 8901A interrupt mask for upper or lower limit
6: eir 7 _____ Enable interrupts
7:
8: for I=1 to 1000 }
9: dsp "I=", I } _____ Dummy main program
10: next I
11: gto -3
12:
13: "limit": rds(714) + S _____ Serial poll 8901A, read status byte into S
14: if bit(3,S)=0 and bit(4,S)=0; iret _____ Check status byte for upper or lower limit
15: fmt ; red 714, D _____ Read FM deviation
16: prt "Dev=", D * 1e-3, " kHz" _____ Print results
17: eir 7 _____ Re-enable interrupts
18: iret _____ Return to main program
```

Figure 6-7. 8901A service request example.

Free run trigger mode provides the fastest reading rate while trigger with settling provides the most consistent readings. In trigger with settling mode the reading rate varies with modulation rate, depth, or deviation, and can be improved as above using audio filters where possible.

## Device Subroutines

When using an instrument in remote operation it is helpful to develop a set of device subroutines to control the main functions of the instrument. These subroutines eliminate the need to remember specific instrument program codes and greatly simplify writing application programs. A comprehensive set of device subroutines is included on pages 42-46 for the 9825A, 9835A, 9845B/T, and HP-1000 controllers. Making use of these subroutines requires the ROMs and interface cards listed in Table 6-6.

It is also necessary to assign the proper value to the subroutine variable which represents the 8901A address. Table 6-7 shows how to assign the address variable, assuming the 8901A address is 14 and the 98034A select code is 7.

The general calling syntax in the subroutines descriptions is given for the 9825A only. The calling syntax for the other controllers is very similar. Table 6-8 shows example calling statements for the audio filter subroutine, Flt. Notice that in the HP-1000 FORTRAN subroutines, the address variable IDLU must always appear first in the calling statement.

**Table 6-6.** Hardware required for 8901A device subroutines.

Controller	Hardware Required
9825A	98210A String and Advanced Programming ROM 98213A General and Extended I/O ROM* 98034A HP-IB Interface Card
9835A	98332A I/O ROM 98034A HP-IB Interface Card
9845B/T	98412A I/O ROM (9845B, 9845T) or 98432A I/O ROM (9845A, 9845S) 98034A HP-IB Interface Card
HP-1000	59310B HP-IB Interface Card

\* The 98214A or 98216A ROM can be substituted for the 98213A ROM.

**Table 6-7.** Example 8901A address variable assignment.

Controller	Variable Name	Assignment Statement
9825A	Ma	dev "Ma", 714
9835A, 9845B/T	Ma	COM Ma Ma = 714
HP-1000	IDLU	IDLU = 14

**Table 6-8.** Example call statements.

Controller	Call Statement
9825A	cII 'Fit' (a <sub>1</sub> , a <sub>2</sub> )
9835A, 9845B/T	CALL Fit (a <sub>1</sub> , a <sub>2</sub> )
HP-1000	CALL FLT (IDLU, a <sub>1</sub> , a <sub>2</sub> )

**Table 6-5.** Typical 8901A measurement rates.

Measurement Mode	Time to Autotune and Return First Reading (Seconds)	Readings/Second After First Reading		
		Trigger Mode		
		Free Run	Immediate	With Settling
AM	1.4 to 2.5	5.8	2.1 to 2.9	1.5 to 2.0
FM	1.6 to 2.5	5.8	1.8 to 3.1	1.4 to 2.2
ΦM	1.6 to 2.5	5.8	1.0 to 3.0	0.9 to 2.1
RF Level	0.40	5.4	4.3	2.5
Frequency resolution				
auto	0.6	3.6	2.3	1.5
10 Hz	0.6 to 0.9	1.0 to 2.75	0.8 to 2.0	0.5 to 1.2
1 kHz	0.6	5.0	3.1	2.0

## Am AM Depth

**Description:** This subroutine measures AM depth.

**Calling Syntax:** cll 'Am' (a<sub>1</sub>)

a<sub>1</sub>—will contain measured AM depth, in %.

**9825A Example:** Measure AM depth

```
cll 'Am' (M)
prt "AM% = ", M
```

**Comments:** This subroutine assumes that the audio filters and detector are already set as desired. The detector and filters can be set using the "Det" and "Flt" subroutines.

### Listing:

#### 9825A

```
1: "Am":
2: fmt ;wrt "Ma", "M1T3";red "Ma",p1
3: ret
*29114
```

#### 9835A,9845B/T

```
400 SUB Am(A)
410 COM Ma
420 OUTPUT Ma USING "K";"M1T3"
430 ENTER Ma;A
440 SUBEND
```

#### HP-1000

```
10 SUBROUTINE AM(IDLU,DEPTH)
WRITE (IDLU,10)
FORMAT("M1T3")
READ (IDLU,*) DEPTH
RETURN
END
```

## Cnt Frequency Count

**Description:** This subroutine sets the modulation analyzer to frequency mode, triggers it, and returns the measured frequency.

**Calling Syntax:** cll 'Cnt' (a<sub>1</sub>)

a<sub>1</sub>—will contain measured frequency in Hz.

**9825A Example:** Make a frequency measurement:

```
cll 'Cnt' (F)
prt "Freq = ", F*1e-6, "MHz"
```

**Comments:** This subroutine uses 10 Hz resolution. In automatic low-noise tuning mode the 8901A takes several readings to return the correct frequency when it must tune to the input signal. The error occurs because the local oscillator is not fully settled by the first reading. To overcome this problem this subroutine uses track mode after tuning. This ensures that the frequency measured in "Cnt" is fully settled and correct. "Cnt" returns the 8901A to automatic low-noise tuning mode before execution returns to the main program. This is only necessary when 10 Hz resolution is requested. If 100 Hz resolution is adequate, the command string "M5T3" provides a faster count.

### Listing:

#### 9825A

```
15: "Cnt":
16: fmt ;wrt "Ma", "M5AU7.1SP4.1SPT3";
red "Ma",p1
17: wrt "Ma", "AU";if (p1-9e9)/100=10;
wrt "Ma", "T3";red "Ma",p1
18: ret
*23503
```

#### 9835A, 9845B/T

```
210 SUB Cnt(F)
220 COM Ma
230 OUTPUT Ma USING "K";"M5AU7.1SP4.1SPT3"
240 ENTER Ma;F
250 OUTPUT Ma USING "K";"AU"
260 IF (F-9E9)/100<>10 THEN SUBEXIT
270 OUTPUT Ma USING "K";"T3"
280 ENTER Ma;F
290 SUBEND
```

#### HP-1000

```
SUBROUTINE CNT(IDLU,FREQ)
DOUBLE PRECISION FREQ
WRITE (IDLU,10)
FORMAT("M5AU7.1SP4.1SPT3")
10 READ (IDLU,*) FREQ
WRITE (IDLU,11)
FORMAT("AU")
11 IF (FREQ-9.E9).NE.10.0) GO TO 99
WRITE (IDLU,12)
FORMAT("T3")
12 READ (IDLU,*)FREQ
99 RETURN
END
```

# Dem

## De-emphasis Filters

**Description:** This subroutine sets the FM de-emphasis filters of the Modulation Analyzer.

**Calling Syntax:** cll 'Dem' (a1, a2)

a1—set to desired de-emphasis, in  $\mu$ s.

a2—If a2 is non-zero the de-emphasis filters are placed before the measurement detector (pre-display). If a2 is set to zero the modulation output is still de-emphasized but after the FM deviation is measured and displayed.

**9825A Example:** Set the 750  $\mu$ s de-emphasis filter but do not use the PRE-DISPLAY mode.

cll 'Dem' (750, 0)

**Comments:** Pre-display mode is most helpful in measuring flatness of FM transmitters with pre-emphasis. If no de-emphasis is desired, set a1 to zero. For the 9825A controller a2 may be omitted rather than setting it equal to zero.

### Listing:

#### 9825A

```
8: "Dem":
9: p1+p0;if p0>=750;100+p0
10: fmt "P",f1.0,"P",f1.0;
    wrt "Ma",p2#0,p0/25+(p0>=25)
11: ret
*22157
```

#### 9835A,9845B/T

```
140 SUB Dem(D,Pre)
150 COM Ma
160 Det=D
170 IF Det>=750 THEN Det=100
180 IMAGE 2("P",D)
190 OUTPUT Ma USING 180;
    Pre<>0,Det/25+(Det>=25)
200 SUBEND
```

#### HP-1000

```
SUBROUTINE DEM(IDLU, IDIS, IDEM)
J=0
L=0
IF (IDIS.NE.0) J=1
IF (IDEM.EQ.750) IDEM=100
IF (IDEM.GT.0) L=IDEM/25+1
WRITE (IDLU,10) J,L
10 FORMAT ("P",I1,"P",I1)
RETURN
END
```

# Det

## Measurement Detectors

**Description:** This subroutine selects the measurement detector of the Modulation Analyzer.

**Calling Syntax:** cll 'Det' (a1, a2)

a1—determines which detector is to be used.

Detector	a1
PEAK +	1
PEAK -	2
AVG	4

a2—If a2 is non-zero the Modulation Analyzer is placed in the PEAK HOLD mode. If set to zero, PEAK HOLD mode is not used.

**9825A Example:** Set the Modulation Analyzer to the PEAK + mode with PEAK HOLD off:

cll 'Det' (1, 0)

**Comments:** The average detector is recommended for residual noise modulation measurements. Peak hold mode is useful in measuring instantaneous modulation transients. Peak hold mode is turned off when the 8901A changes measurement modes (e.g., AM to FM). Therefore, the 8901A must already be in the desired measurement mode (i.e., by a call to "Am" or "Fm") before "Det" is used to set peak hold mode.

### Listing:

#### 9825A

```
12: "Det":
13: fmt "D",f1.0,;wrt "Ma",p1;if p2#0;
    wtb "Ma","D3"
14: ret
*30313
```

#### 9835A, 9845B/T

```
80 SUB Det(Detector,Pkhold)
90 COM Ma
100 IMAGE "D",D
110 OUTPUT Ma USING 100;Detector
120 IF Pkhold<>0 THEN OUTPUT Ma USING "K";"D3"
130 SUBEND
```

#### HP-1000

```
SUBROUTINE DET(IDLU, IDET, IH)
WRITE (IDLU,10) IDET
IF (IH.NE.0) WRITE (IDLU,10) 3
10 FORMAT ("D",I1)
RETURN
END
```

## Flt

### Audio Filters

**Description:** This subroutine sets the high and low-pass filters that determine the measurement bandwidth of the Modulation Analyzer.

**Calling Syntax:** cll 'Flt' (a1, a2)

a1—set to desired high-pass filter, in Hz.

a2—set to desired low-pass filter, in kHz.

**9825A Example:** Set the Modulation Analyzer measurement bandwidth to 300 Hz to 15 kHz:

```
cll 'Flt' (300, 15)
```

**Comments:** If no high-pass filter is desired, set a1 to 0. Similarly, if no low-pass filter is desired, set a2 to 0 (i.e., to turn all the filters off, use ...

```
cll 'Flt' (0,0) ... )
```

#### Listing:

##### 9825A

```
15: "Flt":
16: (p1>0)+(p1>50)→p3;(p2>0)+(p2>3)+
    (p2>15)→p4
17: fmt "H",f1.0,"L",f1.0;wrt "Ma",p3,p4
18: ret
*20419
```

##### 9835A,9845B/T

```
10 SUB Flt(H,L)
20 COM Ma
30 Hp=(H>0)+(H>50)
40 Lp=(L>0)+(L>3)+(L>15)
50 IMAGE "H",D,"L",D
60 OUTPUT Ma USING 50;Hp,Lp
70 SUBEND
```

##### HP-1000

```
SUBROUTINE FLT(IDLU,HP,LP)
IH=0
IL=0
IF (HP.GT.0) IH=1
IF (HP.GT.50) IH=2
IF (LP.GT.0) IL=1
IF (LP.GT.3) IL=2
IF (LP.GT.15) IL=3
WRITE (IDLU,10) IH,IL
10 FORMAT("H",I1,"L",I1)
RETURN
END
```

## Fm

### FM Deviation

**Description:** This subroutine measures FM deviation.

**Calling Syntax:** cll 'Fm' (a1)

a1—will contain measured deviation, in Hz.

**9825A Example:** Measure FM deviation (D) using the PEAK – detector:

```
cll 'Det' (2, 0)
```

```
cll 'Fm' (D)
```

**Comments:** Before this subroutine is called, the audio filters, de-emphasis filters, and detectors should be set as desired using the "Flt", "Dem", and "Det" subroutines.

#### Listing:

##### 9825A

```
19: "Fm":
20: fmt ;wrt "Ma","M2T3";red "Ma",p1
21: ret
*24844
```

##### 9835A, 9845B/T

```
450 SUB Fm(D)
460 COM Ma
470 OUTPUT Ma USING "K";"M2T3"
480 ENTER Ma;D
490 SUBEND
```

##### HP-1000

```
SUBROUTINE FM(IDLU,DEV)
WRITE (IDLU,10)
10 FORMAT("M2T3")
READ (IDLU,*) DEV
RETURN
END
```

# Mtf

## Modulation Analyzer Receive Frequency

**Description:** This subroutine takes the Modulation Analyzer out of the autotuning mode and sets the receive frequency in the manual tune mode. This configures the instrument as a fixed-tuned receiver.

**Calling Syntax:** cll 'Mtf' (a1)

a1—set to desired frequency, in MHz.

**9825A Example:** Set the Modulation Analyzer receive frequency to 132.1 MHz.

```
cll 'Mtf' (132.1)
```

**Comments:** Normally, the analyzer can be operated in autotune mode. This subroutine is recommended only when undesired RF signals are present.

To return the Modulation Analyzer to the autotune mode, use: cll 'Mtf' (0).

### Listing:

#### 9825A

```
25: "Mtf":
26: if pl=0;wtb "Ma","4.0sp";ret
27: fmt f10.5,"MZ";wrt "Ma",pl;ret
*19597
```

#### 9835A,9845B/T

```
320 SUB Mtf(F)
330 COM Ma
340 IF F<>0 THEN GOTO 370
350 OUTPUT Ma USING "K";"4.0SP"
360 SUBEXIT
370 IMAGE 10D.50,"MZ"
380 OUTPUT Ma USING 370;F
390 SUBEND
```

#### HP-1000

```

SUBROUTINE MTF (IDLU, FREQ)
DOUBLE PRECISION FREQ
IF (FREQ.LT.1E-3) GO TO 20
WRITE (IDLU, 10) FREQ
10  FORMAT (F10.5, "MZ")
RETURN
20  WRITE (IDLU, 30)
30  FORMAT ("4.0SP")
RETURN
END
```

# Pep

## Peak Envelope Power

**Description:** This subroutine measures the peak envelope power using the diode detector of the Modulation Analyzer.

**Calling Syntax:** cll 'Pep' (a1)

a1—will contain the measured RF level, in watts.

**9825A Example:** Measure the RF level (P).

```
cll 'Pep' (P)
```

```
prt "Power =", P, "watts"
```

**Comments:** To save testing time ( $\approx 1.5s$ ), this subroutine should be called at the beginning or end of a transmitter test sequence because the analyzer must retune after making RF Level measurements.

### Listing:

#### 9825A

```
22: "Pep":
23: fmt ;wrt "Ma","M4T3";red "Ma",pl
24: ret
*12285
```

#### 9835A,9845B/T

```
270 SUB Pep(P)
280 COM Ma
290 OUTPUT Ma USING "K";"M4T3"
300 ENTER Ma;P
310 SUBEND
```

#### HP-1000

```

SUBROUTINE PEP (IDLU, PWR)
WRITE (IDLU, 10)
10  FORMAT ("M4T3")
READ (IDLU, *) PWR
RETURN
END
```

# Pm

## Phase Deviation

**Description:** This subroutine measures transmitter phase deviation using the Modulation Analyzer.

**Calling Syntax:** cll 'Pm' (a1)

a1—will contain measured deviation, in radians.

**9825A Example:** Measure  $\Phi M$  deviation (D) at a 1 kHz rate using the PEAK detector:

cll 'Pm' (D)

prt "phase dev.=", D\*180/ $\pi$ , "Degrees"

**Comments:** Before this subroutine is called, the audio filters and detectors should be set as desired using the "Flt" and "Det" subroutines.

Because the 8901A recovers phase modulation by integrating the recovered FM, low frequency noise can cause significant display bouncing. Therefore using the 50 Hz or 300 Hz high-pass filter in  $\Phi M$  mode is highly recommended. If no high-pass filters are specified the 8901A defaults to the 50 Hz high-pass filter when it enters  $\Phi M$  mode. When the 50 Hz high-pass filter is turned on by default it is also turned off when the 8901A leaves  $\Phi M$  mode. The subroutine returns the measured phase deviation in radians (a1). To convert a1 to degrees (D), use the following formula:

$$D = a_1 \left( \frac{180}{\pi} \right)$$

### Listing:

#### 9825A

```
28: "Pm":
29: fmt ;wrt "Ma","M3T3";red "Ma",pl
30: ret
*30764
```

#### 9835A, 9845B/T

```
500 SUB Pm(R)
510 COM Ma
520 OUTPUT Ma USING "K";"M3T3"
530 ENTER Ma;R
540 SUBEND
```

#### HP-1000

```
SUBROUTINE PM(IDLU,RAD)
WRITE(IDLU,10)
FORMAT("M3T3")
READ(IDLU,*) RAD
RETURN
END
```

## Example Program

The example program which follows uses the 8901A application subroutines to automatically test an FM mobile transmitter. Figure 6-8 shows the equipment setup. An HP 3325A Synthesizer is used as a programmable audio source to simulate voice signals at the microphone input. The transmitter output is attenuated to the operating level of the 8901A. The 8901A makes the transmitter measurements using the application subroutines. The program generates two plots. The first shows the transmitter pre-emphasis curve. Pre-emphasis is the increase in FM deviation of the transmitter output as audio frequency is increased. For FM mobile transmitters the pre-emphasis is specified at 6 dB/octave between 300 Hz and 3 kHz. The second plot shows transmitter flatness which is the deviation from the ideal pre-emphasis curve. The program takes approximately 4 minutes to run: 2½ minutes to label the titles and graphs, and 1½ minutes to perform the measurements (Figure 6-9). The program also provides an alternate output using the 9825A thermal strip printer (Figure 6-10). The alternate version takes about 45 seconds to run.

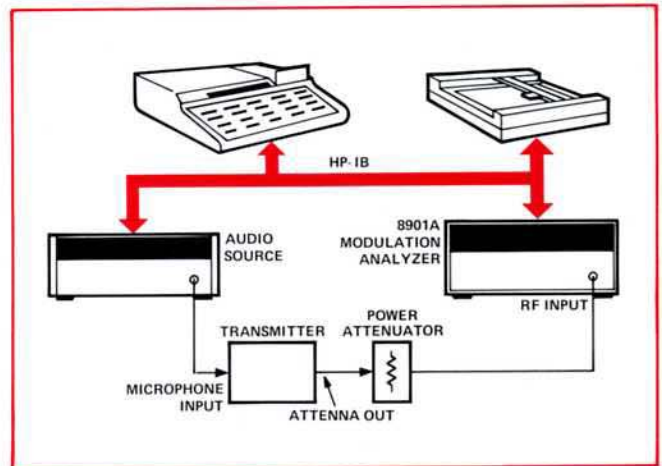

Figure 6-8. Automatic transmitter test equipment setup.



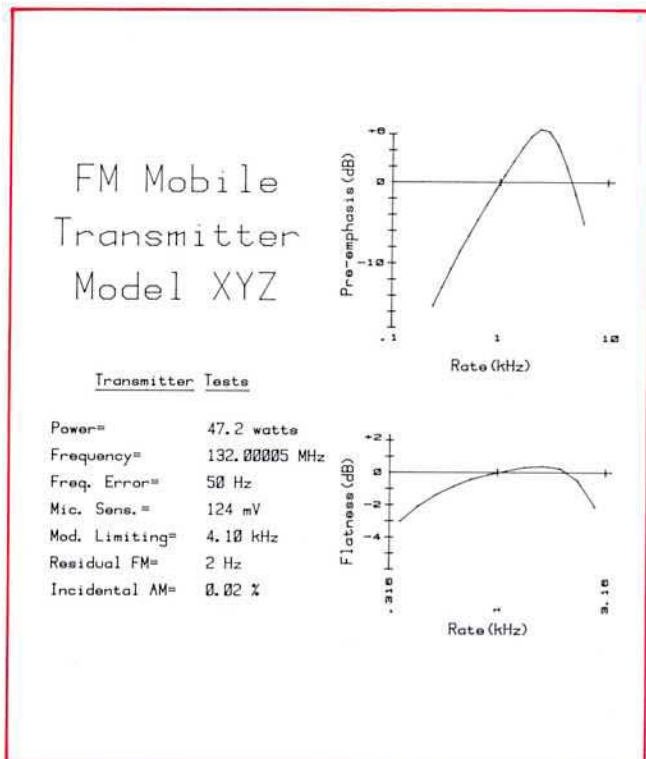

Figure 6-9. Sample output of example application program.

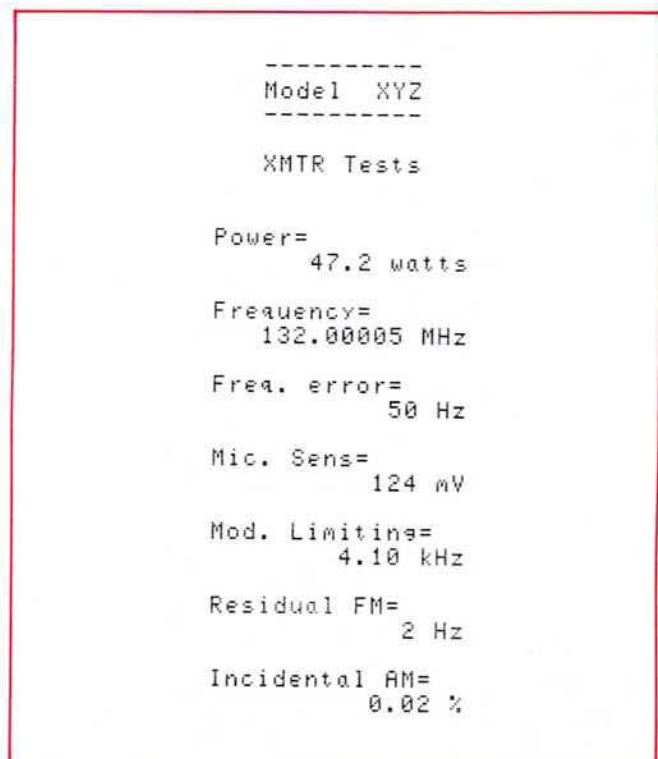

Figure 6-10. Sample alternate output of example program.

## Example Program

```
0: "AN 286-1 FM Mobile test program":
1: dev "3325",717,"Ma",714
2: gto "start"
3: "Init":time 5000;rem 7;cli 7;clr 7
4: fmt ;wrt "Ma","CLAU7.1SPD1H0L0P0C0R0M2"
5: wrt "3325","FULFR1KH-56DB";ret
6:
7: "3325A Device subroutines":
8: "Aff":fmt "FR",f.4,"KH";wrt "3325",p1;ret
9: "Afl":fmt "AM",f.2,"DB";wrt "3325",p1;ret
10:
11: "8901A Device subroutines":
12: "Am":
13: fmt ;wrt "Ma","M1T3";red "Ma",p1
14: ret
15: "Cnt":
16: fmt ;wrt "Ma","M5AU7.1SP4.1SPT3";red "Ma",p1
17: wrt "Ma","AU";if (p1-9e9)/100=10;wrt "Ma","T3";red "Ma",p1
18: ret
19: "Dem":
20: pl→p0;if p0>=750;100→p0
21: fmt "P",f1.0,"P",f1.0;wrt "Ma",p2#0,p0/25+(p0>=25)
22: ret
23: "Det":
24: fmt "D",f1.0;wrt "Ma",p1;if p2#0;wtb "Ma","D3"
25: ret
26: "Flt":
27: (p1>0)+(p1>50)→p3;(p2>0)+(p2>3)+(p2>15)→p4
28: fmt "H",f1.0,"L",f1.0;wrt "Ma",p3,p4
29: ret
30: "Fm":
31: fmt ;wrt "Ma","M2T3";red "Ma",p1
32: ret
33: "Pep":
34: fmt ;wrt "Ma","M4T3";red "Ma",p1
35: ret
36:
37: "Fm/lim":
38: cll 'Afl'(p2)
39: fmt ;wrt "Ma","M2";wait 500
40: cll 'Det'(1,1)
41: cll 'Afl'(p2+20);cll 'Afl'(p2);cll 'Afl'(p2+20)
42: wrt "Ma","T3";red "Ma",p1
43: cll 'Det'(1);cll 'Fm'(p4)
44: cll 'Afl'(p2)
45: ret
46: "Fmsens":
47: if p5=0;3000→p5
48: cll 'Aff'(p2);cll 'Afl'(p4);cll 'Flt'(0,15);cll 'Fm'(p6);p4→p1
49: pl+20log(p5/p6)→p1
50: if abs(p6-p5)<50;ret
51: if pl>25 or pl<-56;prt "*fmsens failed*";ret
52: cll 'Afl'(p1);cll 'Fm'(p6);gto -3
53:
54: "axis":ofs p1,p2
55: plt p3,0;plt p4,0,-1;plt 0,p5;plt 0,p6,-1
56: for I=-int(abs(p3/p7))*p7 to p4 by p7
57: if I#0;plt I,-.6;plt I,.6,-1
58: next I
59: for I=-int(abs(p5/p8))*p8 to p6 by p8
60: if I#0;plt -.6,I;plt .6,I,-1
```

Assign address variables  
Branch to "start" label  
Set 5 second timeout, initialize audio source and 8901A  
Audio frequency (Aff) and level (Afl) subroutines  
8901A device subroutines  
FM modulation limiting subroutine  
Set starting audio source level  
Select FM mode and settle for 500ms  
Select PEAK HOLD and PEAK +  
Increase audio level 20 dB twice  
Trigger and read instantaneous peak deviation  
Select PEAK + detector and read steady-state deviation  
Reset starting audio level  
FM Microphone sensitivity subroutine  
Default to 3 kHz desired FM deviation  
Calculate next audio level  
Return if measured deviation is within 50 Hz of desired  
Set new audio level and measure FM deviation  
Subroutine to draw axes

```

61: next I
62: ofs -p1,-p2;ret
63:
64: "label":ofs p1,p2;csiz 2
65: plt p3,p4,1;lbl A$;csiz 2,2,1,90
66: plt p5,p6,1;lbl B$;csiz 2;ofs -p1,-p2;ret
67:
68: "start":
69: dim A$[20],B$[20],A[20,3],C$[10]
70: ent "Is a 9872A plotter connected",C$
71: if pos(cap(C$),"N")=0;gto "setup"
72: sfg 1;l6→r0;gto "cont"
73:
74: "setup":
75: "Assign plotter address":dev "9872",705
76: psc 705;pclr;pen# 1;wrt "9872","VS20"
77:
78: dsp "Setting up plot. Standby . . ."
79: scl 0,100,0,100
80: csiz 5,2,1,0
81: plt 5,85,1;cplt 1,0;lbl "FM Mobile";cplt -10,-1;lbl "Transmitter"
82: cplt -10,-1;lbl "Model XYZ"
83: csiz 2;plt 12,49,1;lbl "Transmitter Tests"
84: plt 12,48;plt 28,48,-1;plt 30,48;plt 37,48,-1
85: plt 5,40,1;lbl "Power="
86: plt 5,35,1;lbl "Frequency="
87: plt 5,30,1;lbl "Freq. Error="
88: plt 5,25,1;lbl "Mic. Sens.="
89: plt 5,20,1;lbl "Mod. Limiting="
90: plt 5,15,1;lbl "Residual FM="
91: plt 5,10,1;lbl "Incidental AM="
92: "Rate(kHz)"→A$;"Pre-emphasis(dB)"→B$
93: cll 'axis'(60,87,0,36,-27,9,17.5,3)
94: cll 'label'(60,87,10,-35,-6.5,-21)
95: plt 59,96,1;cplt -2,0;csiz 1,1,1;lbl "+6"
96: plt 59,86.5,1;cplt -1,0;lbl "0"
97: plt 59,71.5,1;cplt -3,0;lbl "-10"
98: plt 60,60,1;cplt -1,-1.2;lbl ".1"
99: plt 77.5,60,1;cplt -.5,-1.2;lbl "1"
100: plt 95,60,1;cplt -.5,-1.2;lbl "10"
101: "Flatness(dB)"→B$
102: cll 'axis'(60,33,0,36,-18,7,17.5,3)
103: cll 'label'(60,33,10,-30,-6,-17)
104: plt 59,39,1;cplt -2,0;csiz 1,1,1;lbl "+2"
105: plt 59,32.5,1;cplt -1,0;lbl "0"
106: plt 59,26.5,1;cplt -2,0;lbl "-2"
107: plt 59,20.5,1;cplt -2,0;lbl "-4"
108: plt 60.5,7,1;csiz 1,1,1,90;lbl ".316"
109: plt 78,7,1;lbl "1";plt 95.5,7,1;lbl "3.16";csiz 2
110: "set plotter max. speed (36cm/s)":wrt "9872","VS36"
111: "Use pen #4":pen# 4
112: "Position pen in upper right corner":plt 100,100,1
113: "cont":dsp "Connect next transmitter";stp
114: cll 'Init';cll 'Aff'(1)
115:
116: "Assign XMTR frequency in variable A (in MHz)":
117: l32→A
118:
119: if flgl=0;gto +4
120: fmt 2/,3x,"-----",/,3x,"Model XYZ";wrt r0

```

X and Y axis label subroutine

Start of main program

Ask operator if a 9872A plotter is connected. Press "continue" for yes. If "n" or "no" is entered, flag 1 is set and the thermal strip printer becomes the output device.

Assign plotter address, select pen #1, and set writing speed to 20cm/s

Scale paper in X and Y from 0 to 100

Select large character size

Print titles

Underline previous title

Print test headings

Assign X and Y axis labels

Draw axes for upper plot

Label axes for upper plot

Label Y-axis tic marks

Label X-axis tic marks

Reassign Y-axis label

Draw axes for lower plot

Label axes for lower plot

Label Y-axis tic marks

Label X-axis tic marks

Display prompt and wait for operator to connect the transmitter

Print test heading on the strip printer if flag 1 is set

## Example Program (continued)

```
121: fmt 3x,"-----",2/,3x,"XMTR Tests",2/;wrt r0
122:
123: cll 'Pep'(P)
124: "Compensate reading for 30db Pad (P*le3)":
125: if flgl;fmt "Power=",/,5x,f5.1," watts",/;wrt r0,P*le3;gto +3 } Measure power
126: plt 29,40,1;fxd 1;lbl P*le3," watts"
127:
128: cll 'Cnt'(F);F-A*le6→E ----- Measure frequency
129: if flgl=0;gto +3
130: fmt "Frequency=",/,2x,f10.5," MHz",/;wrt r0,F*le-6
131: fmt "Freq. error=",/,8x,f5.0," Hz",/;wrt r0,E;gto +5 } Print frequency
132: plt 29,35,1;fxd 5;lbl F*le-6," MHz" and frequency error
133: plt 29,30,1;fxd 0;lbl E," Hz"
134:
135: "Use -7 dBm for starting Mic. sens.' estimate":
136: cll 'Fmsens'(M,1,F,-7);1000√.05tn^(M/20)→S ----- Measure microphone sensitivity,
137: if flgl;fmt "Mic. Sens=",/,9x,f4.0," mV",/;wrt r0,S;gto +3 ----- & convert dBm (50Ω) to mV
138: plt 29,25,1;fxd 0;lbl S," mV" ----- Output result
139:
140: cll 'Fm/lim'(D,M) ----- Measure instantaneous modulation limiting
141: if flgl;fmt "Mod. Limiting=",/,7x,f5.2," kHz",/;wrt r0,D*le-3;gto +3
142: plt 29,20,1;fxd 2;lbl D*le-3," kHz" ----- Output result
143:
144: "Set Audio source to min level ":
145: cll 'Afl'(-56);cll 'Aff'(100) } Measure residual FM
146: cll 'Flt'(300,3);cll 'Det'(4);cll 'Fm'(R) }
147: fmt ;wrt "Ma","T3";red "Ma",R ----- Take additional reading to ensure proper setting
148: if flgl;fmt "Residual FM=",/,9x,f4.0," Hz",/;wrt r0,R;gto +3 ----- Output result
149: plt 29,15,1;fxd 0;lbl R," Hz"
150:
151: cll 'Aff'(1);cll 'Afl'(M) ----- Reset audio source to microphone sensitivity setting
152: cll 'Flt'(50,3);cll 'Det'(1);cll 'Am'(A) ----- Measure incidental AM
153: if flgl;fmt "Incidental AM=",/,9x,f5.2," %",3/;wrt r0,A;gto "fin" ----- Output
154: plt 29,10,1;fxd 2;lbl A," %" ----- Result
155:
156: "Measure reference data points":
157: cll 'Flt'(0,15);cll 'Dem'(0);cll 'Fmsens'(R,1,F,M-9,1000) ----- Measure pre-emphasis
158: cll 'Dem'(750,1);cll 'Fm'(S)
159:
160: "Set up logarithmic audio sweep": } Compute log increment (V) for an 18 point
161: .2→T;6→U;18→N;(U/T)^(1/N)→V;T/V→T } sweep from 200 Hz to 6 kHz
162:
163: "Plot pre-emphasis curve":
164: ofs 60,87;cll 'Dem'(0) ----- Offset pen, turn off PRE-DISPLAY
165: for I=1 to N+1
166: T*V→T+A[I,1];cll 'Aff'(A[I,1]) ----- Increment and store audio frequency
167: cll 'Fm'(A[I,2])
168: 20log(A[I,2]/1000)→X;if X<-16;gto +2 } Normalize measured deviation in dB (X)
169: plt log(A[I,1]/.1)*17.5,1.5*X } and plot if X is greater than -16
170: next I
171: pen;ofs -60,-87 ----- Lift pen, clear pen offset
172:
173: "Plot flatness":
174: ofs 60,33;1→I;cll '750,1) ----- Set new pen offset and 750μs PRE-DISPLAY mode
175: if A[I,1]≤.315;gto +3 ----- Skip to next point if frequency is less than 315 Hz
176: cll 'Aff'(A[I,1]);cll 'Fm'(A[I,3])
177: plt log(A[I,1]/.315)*35,20log(A[I,3]/S)*3 ----- Scale measurement in plotter units and plot
178: if A[I+1-I,1]<3.16;gto -3 ----- Increment to next point if frequency is less than 3.16 kHz
179: pen# ;ofs -60,-33;plt 100,100,1 ----- Put pen away, position pen holder in upper right corner
180: "fin":dsp "done";stp
181: end
```

## Bus Commands

Table 6-9 lists the IEEE 488 bus commands to which the 8901A responds. Hewlett-Packard instrument controllers automatically use these commands making them transparent to the programmer.

**Table 6-9.** Bus commands to which the 8901A responds.

	Function	Command	Response
<b>Device control</b>	Address	Talk Listen	8901A outputs measurement result and remains in local or remote. 8901A goes to remote and listens for data.
	Unaddress	UNT Untalk UNL Unlisten	If talking 8901A is unaddressed. 8901A ceases to listen to data.
	Clear	DCL Device Clear SDC Selective Device Clear	Sets 8901A to automatic operation, frequency measurement mode, and trigger to free run.
	Remote	REN Remote Enable GTL Go to local REN Remote Disable	8901A remains in local until first addressed to listen. 8901A returns to local control, all instrument functions and settings are unchanged.
	Local Lockout Trigger	LL0 Local Lockout GET Group Execute Trigger	Disables all front panel keys. 8901A makes a settled measurement (same as program code T3).
<b>Interrupt/ Status</b>	Require Service Status Byte	SRQ Service Request SPE Serial Poll Enable SPD Serial Poll Disable	8901A requests service when service request mask conditions occur. Sets serial poll mode and latches RQS in 8901A. Terminates serial poll mode.
<b>Abort</b>	Abort	IFC Interface Clear	8901A ceases to talk or listen.

